



РЕМСТАНМАШ
ТЕХНОЛОГИИ ДЛЯ ПРОИЗВОДСТВА

ООО «РемСтанМаш»

Адрес: г. Смоленск, улица Верхне-Сенная улица, дом 4, офис № 409.

Телефон: 8-800-511-02-67

Телефон: +7-919-0-46-48-46

E-mail: info@cnchelp.ru

Сайт: www.cnchelp.ru



Product Information

LC 1x3

LC 4x3

Absolute Linear Encoders

LC 100 series

- Absolute linear encoders for measuring steps to 0.1 µm (resolution to 0.005 µm)
- High vibration rating
- Horizontal mounting possible
- Up to two additional scanning units are possible

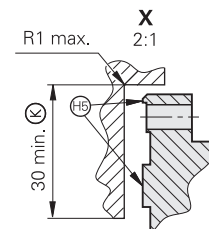
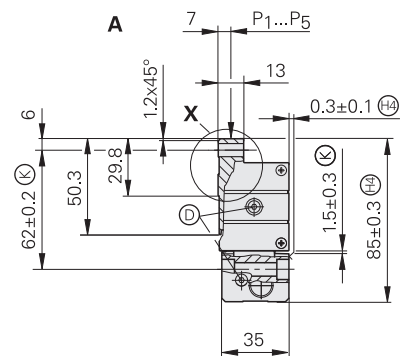
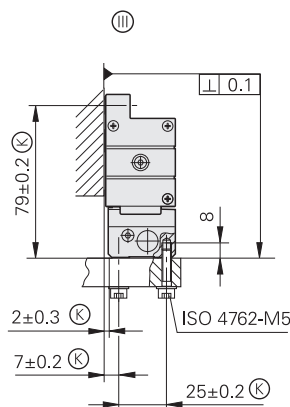
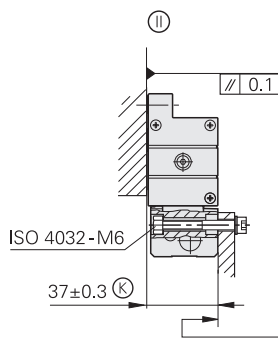
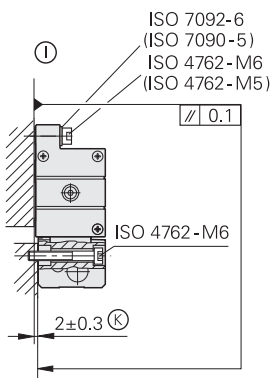
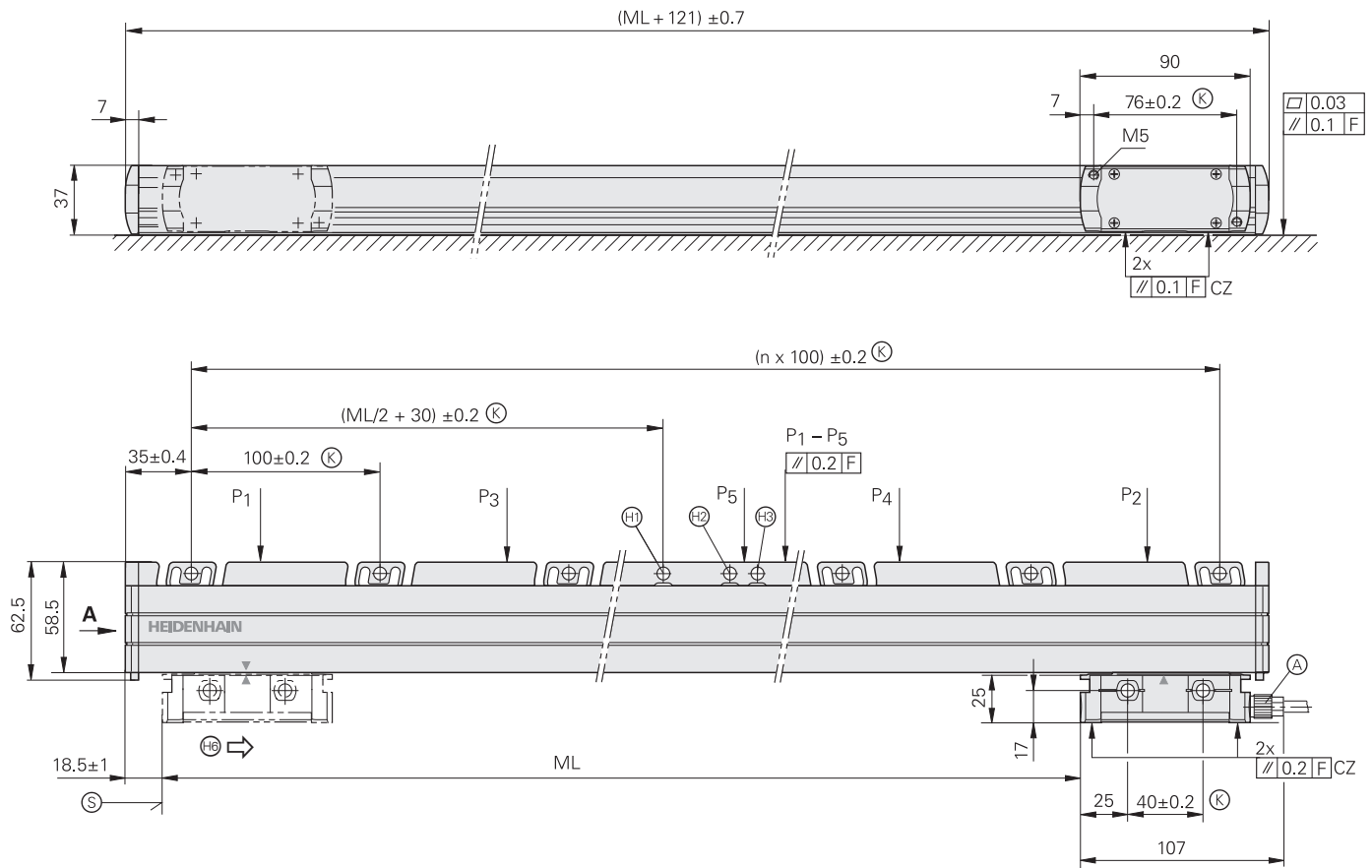

mm
 Tolerancing ISO 8015
 ISO 2768 - m H
 < 6 mm: ±0.2 mm

- ⓪, Ⓛ, Ⓜ = Mounting options
- F = Machine guideway
- P = Gauging points for alignment
- Ⓐ = Cable connection usable at either end
- Ⓚ = Required mating dimensions
- Ⓛ = Compressed air inlet usable at either end
- Ⓜ = Beginning of measuring length ML (20 mm absolute)
- Ⓝ = Mechanical fixed point (to be preferred)
- Ⓞ = Mechanical fixed point, compatible to predecessor model
- Ⓟ = Mechanical fixed point (coincides with the spacing interval of 100 mm)
- Ⓠ = Alternative mating dimensions
- Ⓡ = Mating surfaces
- Ⓢ = Direction of scanning unit motion for output signals in accordance with interface description



Specifications	LC 183	LC 193 F	LC 193 M
Measuring standard Coefficient of linear expansion	DIADUR glass scale with absolute track and incremental track $\alpha_{\text{therm}} \approx 8 \times 10^{-6} \text{ K}^{-1}$		
Accuracy grade*	$\pm 3 \mu\text{m}$ (up to measuring length 3040); $\pm 5 \mu\text{m}$		
Measuring length ML* in mm	140 1540 4040	240 1640 4240	340 440 540 640 740 840 940 1040 1140 1240 1340 1440
Absolute position values*	EnDat 2.2 <i>Ordering designation</i> EnDat 02	Fanuc 02 serial interface	Mitsubishi high speed serial interface, Mit 02-4 or Mitsu 01
Resolution <i>Accuracy $\pm 3 \mu\text{m}$</i> <i>Accuracy $\pm 5 \mu\text{m}$</i>	0.005 μm 0.01 μm	0.01 μm 0.05 μm	
Calculation time t_{cal} <i>EnDat 2.1 command set</i> <i>EnDat 2.2 command set</i>	< 1 ms $\leq 5 \mu\text{s}$	– –	
Incremental signals	$\sim 1 \text{ V}_{\text{PP}}^{1)}$	–	
Grating period/signal period	20 μm	–	
Cutoff frequency –3dB	$\geq 150 \text{ kHz}$	–	
Power supply Without load	3.6 to 5.25 V / < 300 mA		
Electrical connection	Separate adapter cable (1 m/3 m/6 m/9 m) connectable on both sides to mounting block		
Cable length ²⁾	$\leq 150 \text{ m}$; depending on the interface and subsequent electronics	$\leq 30 \text{ m}$	$\leq 20 \text{ m}$
Traversing speed	$\leq 180 \text{ m/min}$		
Required moving force	$\leq 4 \text{ N}$		
Vibration 55 to 2000 Hz Shock 11 ms Acceleration	$\leq 200 \text{ m/s}^2$ (EN 60068-2-6) $\leq 300 \text{ m/s}^2$ (EN 60068-2-27) $\leq 100 \text{ m/s}^2$ in measuring direction		
Operating temperature	0 to 50 °C (as of ML 3240, the storage temperature range is restricted to –10 °C to +50 °C)		
Protection EN 60529	IP 53 when mounted according to the instructions and mounting information IP 64 if compressed air is connected via DA 400		
Weight	0.4 kg + 3.3 kg/m measuring length		

* Please select when ordering

¹⁾ Depending on the adapter cable

²⁾ With HEIDENHAIN cable

LC 400 series

- Absolute linear encoders for measuring steps to 0.1 μm (resolution to 0.005 μm)
- For limited installation space
- Up to two additional scanning units are possible

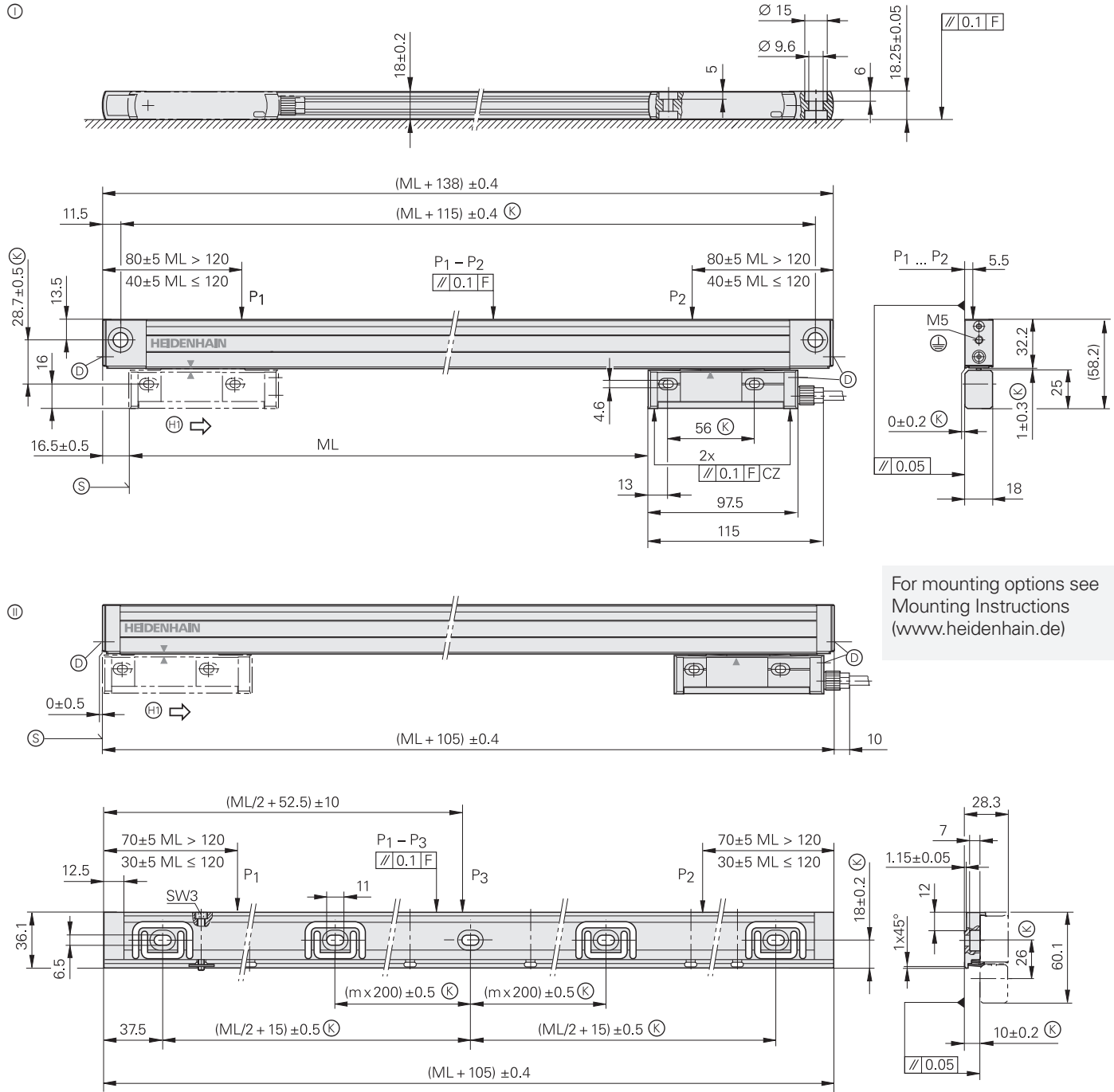

For mounting options see
Mounting Instructions
(www.heidenhain.de)

mm

 Tolerancing ISO 8015
 ISO 2768 - m H
 < 6 mm: ±0.2 mm

- ⊙ = Without mounting spar (with M8 screws)
- ⊕ = Mounting with mounting spar (LC 483 with short end pieces shown; LC with normal end pieces can also be mounted)
- F = Machine guideway
- P = Gauging points for alignment
 ML ≤ 820 P₁ - P₂
 ML > 820 P₁ - P₃
- ⊗ = Required mating dimensions
- ⊕ = Compressed air inlet
- ⊙ = Beginning of measuring length (ML) at 20 mm
- ⊙ = Direction of scanning unit motion for output signals in accordance with interface description

Mounting spar

ML	m
70 ... 520	0
570 ... 920	1
1020 ... 1340	2
1440 ... 1740	3
1840 ... 2040	4

LC 483 without mounting spar



LC 483 with mounting spar

Specifications	LC 483	LC 493F	LC 493M
Measuring standard Coefficient of linear expansion	DIADUR glass scale with absolute track and incremental track $\alpha_{\text{therm}} \approx 8 \times 10^{-6} \text{ K}^{-1}$ (mounting type ①); <i>with mounting spar</i> : $\alpha_{\text{therm}} \approx 9 \times 10^{-6} \text{ K}^{-1}$ (mounting type ②)		
Accuracy grade*	$\pm 3 \mu\text{m}$; $\pm 5 \mu\text{m}$		
Measuring length ML* in mm	Mounting spar* or clamping elements* optional 70 120 170 220 270 320 370 420 470 520 570 620 670 720 770 820 870 920 1020 1140 1240 Mounting spar* or clamping elements* required 1340 1440 1540 1640 1740 1840 2040		
Absolute position values*	EnDat 2.2 <i>Ordering designation</i> EnDat 02	Fanuc 02 serial interface	Mitsubishi high speed serial interface, Mit 02-4 or Mitsu 01
Resolution <i>Accuracy $\pm 3 \mu\text{m}$</i> <i>Accuracy $\pm 5 \mu\text{m}$</i>	0.005 μm 0.01 μm	0.01 μm 0.05 μm	
Calculation time t_{cal} <i>EnDat 2.1 command set</i> <i>EnDat 2.2 command set</i>	< 1 ms $\leq 5 \mu\text{s}$	– –	
Incremental signals	$\sim 1 \text{ V}_{\text{PP}}^{1)}$	–	
Grating period/signal period	20 μm	–	
Cutoff frequency –3dB	$\geq 150 \text{ kHz}$	–	
Power supply Without load	3.6 to 5.25 V/< 300 mA		
Electrical connection	Separate adapter cable (1 m/3 m/6 m/9 m) connectable to mounting block		
Cable length ²⁾	$\leq 150 \text{ m}$; depending on the interface and subsequent electronics	$\leq 30 \text{ m}$	$\leq 20 \text{ m}$
Traversing speed	$\leq 180 \text{ m/min}$		
Required moving force	$\leq 5 \text{ N}$		
Vibration 55 to 2000 Hz Shock 11 ms Acceleration	<i>Without mounting spar</i> : $\leq 100 \text{ m/s}^2$ (EN 60068-2-6) <i>With mounting spar and cable outlet at right/left</i> : $\leq 200 \text{ m/s}^2/100 \text{ m/s}^2$ (EN 60068-2-6) $\leq 300 \text{ m/s}^2$ (EN 60068-2-27) $\leq 100 \text{ m/s}^2$ in measuring direction		
Operating temperature	0 °C to 50 °C		
Protection EN 60529	IP 53 when mounted according to the instructions and mounting information IP 64 if compressed air is connected via DA 400		
Weight	<i>Encoder</i> : 0.2 kg + 0.5 kg/m measuring length, <i>mounting spar</i> : 0.9 kg/m		





* Please select when ordering

¹⁾ Depending on the adapter cable



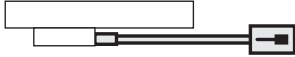

²⁾ With HEIDENHAIN cable





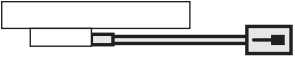
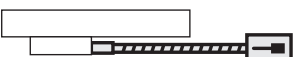

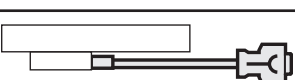
Electrical connection

Adapter cables

For absolute linear encoders – EnDat		Cable Ø	LC 183 LC 483 With incremental signals	LC 183 LC 483 Without incremental signals
Adapter cable with M23 coupling (male), 17-pin		6 mm	533631-xx	–
Adapter cable in metal armor with M23 coupling (male), 17-pin		10 mm	558362-xx	–
Adapter cable with D-sub connector, 15-pin		6 mm	558714-xx	–
Adapter cable with M12 coupling (male), 8-pin		4.5 mm	–	533661-xx
Adapter cable in metal armor with M12 coupling (male), 8-pin		10 mm	–	550678-xx

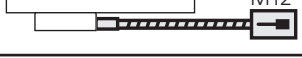
Available cable lengths: 1 m/3 m/6 m/9 m

For absolute linear encoders – Fanuc		Cable Ø	LC 193 F LC 493 F
Adapter cable with M23 coupling (male), 17-pin		4.5 mm	547300-xx
Adapter cable in metal armor with M23 coupling (male), 17-pin		10 mm	555541-xx
Adapter cable with M12 coupling (male), 8-pin		4.5 mm	533661-xx
Adapter cable in metal armor with M12 coupling (male), 8-pin		10 mm	550678-xx
Adapter cable with Fanuc connector, 20-pin		4.5 mm	545547-xx
Adapter cable in metal armor with Fanuc connector, 20-pin		10 mm	551027-xx

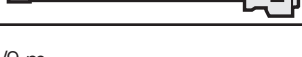
For absolute linear encoders – Mitsubishi		Cable Ø	LC 193M LC 493M
Adapter cable with M23 coupling (male), 17-pin		4.5 mm	547300-xx
Adapter cable in metal armor with M23 coupling (male), 17-pin		10 mm	555541-xx
Adapter cable with M12 coupling (male), 8-pin		4.5 mm	533661-xx
Adapter cable in metal armor with M12 coupling (male), 8-pin		10 mm	550678-xx
Adapter cable with Mitsubishi connector, 10-pin		4.5 mm	640915-xx
Adapter cable with Mitsubishi connector, 20-pin		4.5 mm	599685-xx
Adapter cable in metal armor with Mitsubishi connector, 10-pin		10 mm	640916-xx
Adapter cable in metal armor with Mitsubishi connector, 20-pin		10 mm	599688-xx

Available cable lengths: 1 m/3 m/6 m/9 m





Electrical connection

EnDat connecting cables





17-pin
M23



8-pin
M12

For EnDat with incremental signals	For EnDat without incremental signals
--	---

PUR connecting cables		8-pin: [(4 × 0.14 mm ²) + (4 × 0.34 mm ²)] 17-pin: [(4 × 0.14 mm ²) + 4(2 × 0.14 mm ²) + (4 × 0.5 mm ²)]	Ø 6 mm Ø 8 mm
Complete with connector (female) and coupling (male)		323897-xx	368330-xx
Complete with connector (female) and D-sub connector (female) for IK 220		332115-xx	533627-xx
Complete with connector (female) and D-sub connector (male) for IK 115/IK 215		324544-xx	524599-xx
With one connector (female)		309778-xx	559346-xx
Cable without connectors , Ø 8 mm		266306-01	–





Connecting cables Fanuc Mitsubishi





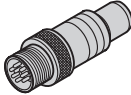

		Cable	Fanuc	Mitsubishi
PUR connecting cable for M23 connecting elements				
Complete with 17-pin M23 connector (female) and Fanuc connector [[2 x 2 x 0.14 mm ²) + (4 x 1 mm ²)]	 Fanuc	Ø 8 mm	534855-xx	–
Complete with 17-pin M23 connector (female) and 20-pin Mitsubishi connector [[2 x 2 x 0.14 mm ²) + (4 x 0.5 mm ²)]	 Mitsubishi 20-pin	Ø 6 mm	–	367958-xx
Complete with 17-pin M23 connector (female) and 10-pin Mitsubishi connector [[2 x 2 x 0.14 mm ²) + (4 x 1 mm ²)]	 Mitsubishi 10-pin	Ø 8 mm	–	573661-xx
Cable only [[2 x 2 x 0.14 mm ²) + (4 x 1 mm ²)]		Ø 8 mm	354608-01	

		Cable	Fanuc	Mitsubishi
PUR connecting cable for M12 connecting elements				
Complete with 8-pin M12 connector (female) and Fanuc connector [[1 x 4 x 0.14 mm ²) + (4 x 0.34 mm ²)]	 Fanuc	Ø 6 mm	646807-xx	–
Complete with 8-pin M12 connector (female) and 20-pin Mitsubishi connector [[1 x 4 x 0.14 mm ²) + (4 x 0.34 mm ²)]	 Mitsubishi 20-pin	Ø 6 mm	–	646806-xx
Complete with 8-pin M12 connector (female) and 10-pin Mitsubishi connector [[1 x 4 x 0.14 mm ²) + (4 x 0.34 mm ²)]	 Mitsubishi 10-pin	Ø 6 mm	–	647314-xx

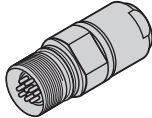
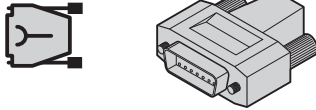
Pin layout

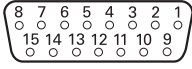
EnDat

8-pin coupling, M12								
								
	Power supply				Absolute position values			
	8	2	5	1	3	4	7	6
	U_P	Sensor U_P	0V	Sensor 0V	DATA	DATA	CLOCK	CLOCK
	Brown/Green	Blue	White/Green	White	Gray	Pink	Violet	Yellow

17-pin coupling, M23						15-pin D-sub connector For HEIDENHAIN controls and IK 220							
													
													
	Power supply					Incremental signals ¹⁾				Absolute position values			
	7	1	10	4	11	15	16	12	13	14	17	8	9
	1	9	2	11	13	3	4	6	7	5	8	14	15
	U_P	Sensor U_P	0V	Sensor 0V	Internal shield	A+	A-	B+	B-	DATA	DATA	CLOCK	CLOCK
	Brown/ Green	Blue	White/ Green	White	/	Green/ Black	Yellow/ Black	Blue/ Black	Red/ Black	Gray	Pink	Violet	Yellow







Cable shield connected to housing; **U_P** = Power supply voltage

Sensor: The sensor line is connected in the encoder with the corresponding power line.

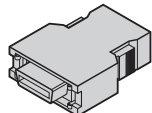
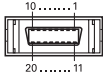
Vacant pins or wires must not be used!

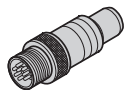
¹⁾ Only with ordering designations EnDat 01 and EnDat 02









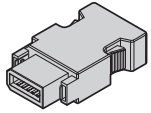

Fanuc and Mitsubishi

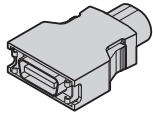
20-pin Fanuc connector					8-pin coupling, M12				
									
	Power supply					Absolute position values			
	9	18/20	12	14	16	1	2	5	6
	8	2	5	1	–	3	4	7	6
	U _P	Sensor U _P	0V	Sensor 0V	Shield	Serial Data	Serial Data	Request	Request
	Brown/Green	Blue	White/Green	White	–	Gray	Pink	Violet	Yellow

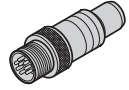
Cable shield connected to housing; **U_P** = power supply voltage

Sensor: The sensor line is connected in the encoder with the corresponding power line.

Vacant pins or wires must not be used!

10-pin Mitsubishi connector			20-pin Mitsubishi connector			8-pin coupling, M12			
									
	Power supply					Absolute position values			
	10-pin	1	–	2	–	7	8	3	4
	20-pin	20	19	1	11	6	16	7	17
		8	2	5	1	3	4	7	6
		U _P	Sensor U _P	0V	Sensor 0V	Serial Data	Serial Data	Request Frame	Request Frame
		Brown/Green	Blue	White/Green	White	Gray	Pink	Violet	Yellow

Cable shield connected to housing; **U_P** = power supply voltage

Sensor: The sensor line is connected in the encoder with the corresponding power line.

Vacant pins or wires must not be used!

HEIDENHAIN

DR. JOHANNES HEIDENHAIN GmbH

Dr.-Johannes-Heidenhain-Straße 5

83301 Traunreut, Germany

☎ +49 8669 31-0

FAX +49 8669 5061

E-mail: info@heidenhain.de

www.heidenhain.de

For more information:

- Catalog: *Linear Encoders for Numerically Controlled Machine Tools*