

Spannungsversorgung
Power supply

Up: DC 5 V ± 0.25 V
(am Gerät, at encoder).
Imax. 130 mA
(ohne Last, Without load).

Ausgangssignale
Output signals

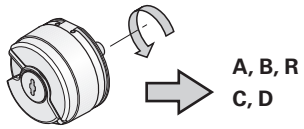

A, B, R
C, D

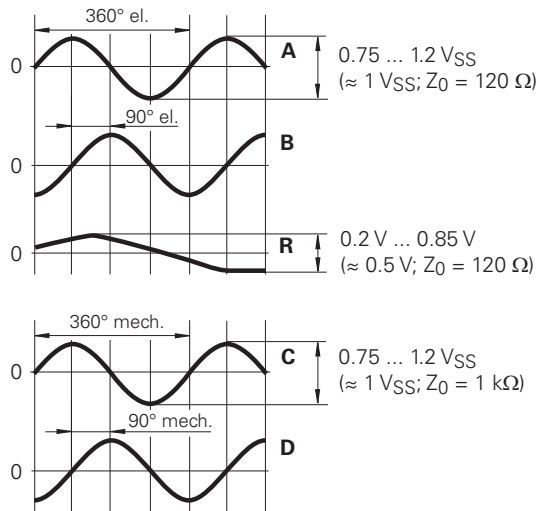

Allgemeine Hinweise
General Information

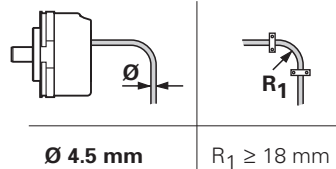
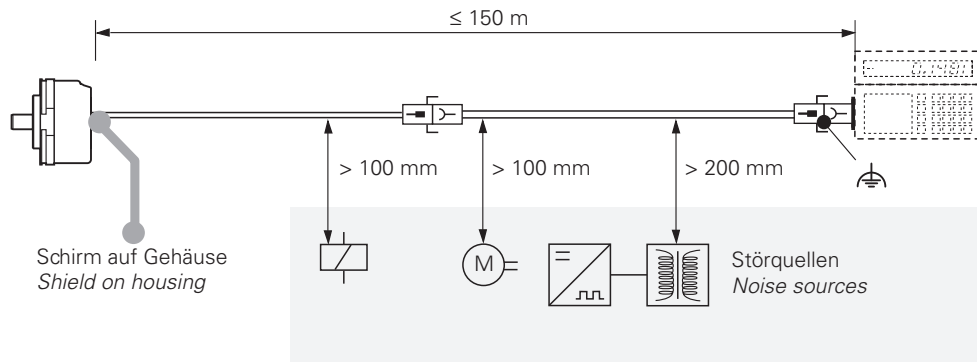

Referenzmarkenlage Welle - Kappe
Reference mark for shaft/cap alignment

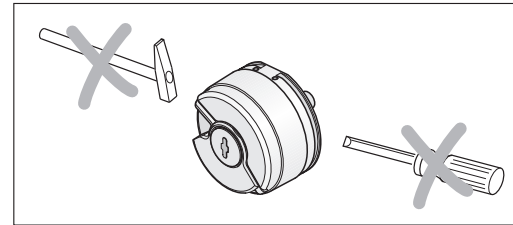
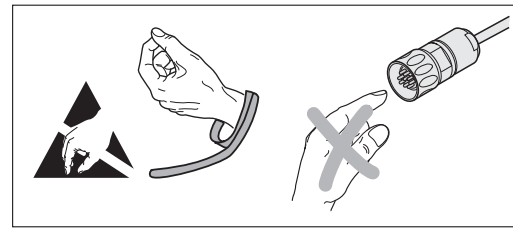
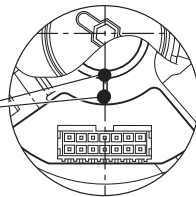

Montagesatz im Lieferumfang
Mounting kit included

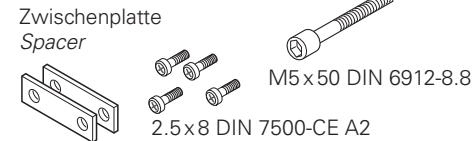

HEIDENHAIN

Montageanleitung
Mounting Instructions

ERN 1387.035

5/2013



Achtung: Die Montage und Inbetriebnahme ist von einer qualifizierten Fachkraft unter Beachtung der örtlichen Sicherheitsvorschriften vorzunehmen.
Zusätzlich muss der Maschinenhersteller/-konstrukteur die erforderlichen weiteren Angaben zur Endmontage (z.B. Losdrehicherung für Schrauben ja/nein) für die jeweilige Anwendung selber festlegen.
Die Steckverbindung darf nur spannungsfrei verbunden oder gelöst werden.
Der Antrieb darf während der Montage nicht in Betrieb gesetzt werden.

Note: Mounting and commissioning is to be conducted by a qualified specialist under compliance with local safety regulations.
In addition to this, the machine manufacturer or designer himself must define the other data required for final assembly (e.g. anti-rotation lock for screws required or not) for the respective application.
Do not engage or disengage any connections while under power.
The drive must not be put into operation during installation.

DR. JOHANNES HEIDENHAIN GmbH

Technical support, measuring systems ☎ +49 8669 31-3104 · E-mail: service.ms-support@heidenhain.de

1073758-90 · Ver00 · Printed in Germany · 5/2013 · H



