



PWT 100 PWT 101 Operating Instructions

Contents

1	Fundamentals.....	9
2	Safety.....	17
3	Transport and storage.....	23
4	Mounting.....	27
5	Installation.....	29
6	Basic operation.....	39
7	Main menu.....	49
8	Encoder diagnostics.....	53
9	Settings menu.....	123
10	Module management menu.....	129
11	Information menu.....	137
12	Servicing and maintenance.....	141
13	What to do if	145
14	Removal and disposal.....	149
15	Specifications.....	153
16	Index.....	158

1	Fundamentals.....	9
1.1	About these instructions.....	10
1.2	Information on the product.....	10
1.3	Notes on reading the documentation.....	12
1.4	Storage and distribution of the documentation.....	13
1.5	Target groups for the instructions.....	13
1.6	Notes in this documentation.....	13
1.7	Symbols and fonts used for marking text.....	15
2	Safety.....	17
2.1	General safety precautions.....	18
2.2	Intended use.....	18
2.3	Improper use.....	18
2.4	Personnel qualification.....	19
2.5	Obligations of the operating company.....	19
2.6	General safety precautions.....	19
2.6.1	Symbols on the product.....	20
2.6.2	Electrical safety precautions.....	20
2.6.3	Safety precautions for operation with and in numerically controlled machines.....	21
3	Transport and storage.....	23
3.1	Overview.....	24
3.2	Unpacking.....	24
3.3	Items supplied and accessories.....	24
3.4	In case of damage in transit.....	24
3.5	Repackaging and storage.....	25
3.5.1	Repackaging the product.....	25
3.5.2	Storage of the product.....	25

4	Mounting.....	27
4.1	Overview.....	28
4.2	Mounting location.....	28
5	Installation.....	29
5.1	Overview.....	30
5.2	General information.....	30
5.3	Device overview.....	31
5.4	Connecting the product.....	32
5.5	Connecting encoders.....	33
5.6	Connecting a computer.....	37
5.7	Connecting an external device.....	38
6	Basic operation.....	39
6.1	Overview.....	40
6.2	Menus and screens.....	40
6.3	Operating elements.....	42
6.4	Gestures.....	43
6.5	On-screen keyboard.....	44
6.6	Switch-on/Switch-off.....	45
6.7	Setting the language.....	45
6.8	Creating a screenshot.....	46
6.9	Power supply of the encoder.....	47
7	Main menu.....	49
7.1	Overview.....	50
7.2	Opening the Main menu.....	51

8	Encoder diagnostics.....	53
8.1	Various diagnostics screens.....	54
8.2	Performing Automatic Diagnosis.....	55
8.3	Performing Manual Diagnosis.....	56
8.4	Diagnosis for encoders with serial interface.....	58
8.4.1	Online diagnostics screen.....	58
8.4.2	Temperature screen.....	61
8.4.3	Encoder information screen.....	62
8.4.4	Position screen.....	63
8.4.5	PWT display screen.....	63
8.4.6	Level display screen.....	63
8.4.7	More menu.....	64
8.4.8	Encoder status screen.....	70
8.5	Diagnostics for encoders with 1 V_{PP}/11 μA_{PP}/1 V_{PP} + Z1 interface.....	73
8.5.1	PWT display screen.....	73
8.5.2	Sine commutation (1 V _{PP} + Z1) screen.....	79
8.5.3	Encoder information screen.....	80
8.5.4	Counts screen.....	81
8.5.5	Switching signals screen.....	82
8.5.6	More menu.....	83
8.5.7	Encoder status screen.....	90
8.6	Diagnosis for encoders with TTL/HTL/HTLs/ interface.....	92
8.6.1	Level display screen for TTL/HTL/HTLs.....	93
8.6.2	Encoder information screen for TTL/HTL/HTLs.....	94
8.6.3	Counts screen for TTL/HTL/HTLs.....	95
8.6.4	Switching signals screen for TTL.....	96
8.6.5	PWT display screen for TTL.....	97
8.6.6	More menu for TTL/HTL/HTLs.....	103
8.6.7	Encoder status screen for TTL/HTL/HTLs.....	111
8.7	Diagnosis for encoders with DRIVE-CLiQ interface.....	113
8.7.1	Online diagnostics screen.....	113
8.7.2	Temperature screen.....	116
8.7.3	Encoder information screen.....	117
8.7.4	Position screen.....	118
8.7.5	More menu.....	119
8.7.6	Encoder status screen.....	120

9	Settings menu.....	123
9.1	Overview.....	124
9.2	Language settings screen.....	124
9.3	General settings screen.....	125
9.4	Screen settings screen.....	126
9.5	Restart device screen.....	127
10	Module management menu.....	129
10.1	Overview.....	130
10.2	Module management flash screen.....	131
10.3	Module management memory card screen.....	132
10.4	Module action screen.....	133
10.5	License key management screen.....	135
11	Information menu.....	137
11.1	Overview.....	138
11.2	Information screen.....	138
11.3	Licenses screen.....	139
12	Servicing and maintenance.....	141
12.1	Overview.....	142
12.2	Cleaning.....	142
12.3	Maintenance schedule.....	143
12.4	Updating the firmware.....	144
13	What to do if	145
13.1	Overview.....	146
13.2	Malfunctions.....	146
13.3	Troubleshooting.....	146

14 Removal and disposal.....	149
14.1 Overview.....	150
14.2 Removal from numerically controlled machines.....	150
14.3 Disposal.....	151
15 Specifications.....	153
15.1 Product data.....	154
15.2 Device dimensions and mating dimensions.....	157
16 Index.....	158

1

Fundamentals

1.1 About these instructions

These instructions provide all the information and safety precautions needed for the safe operation of the device.

1.2 Information on the product

Product designation	ID number	Basic firmware	Index
PWT 100	1077164-xx	3.0.x	–
PWT 101	1225922-xx	3.0.x	–

i The devices of the PWT 101 series are successor devices to the PWT 100 series. The devices permit the use of the basic firmware as well as various loadable modules. Different information (e.g., in the "Installation" and "Specifications" chapters) may apply to the loadable modules. The applicable information can be found in the relevant module documentation at www.heidenhain.com.

i The functions provided by the product vary depending on the firmware. Basic firmware 3.0.x supports the following:

- Purely serial interfaces: EnDat, Fanuc, Mitsubishi, Panasonic, Yaskawa, DRIVE-CLiQ
- Incremental interfaces: 1 V_{PP}, 11 μA_{PP}, TTL, 1 V_{PP} + Z1, HTL, HTLs (via signal adapter ID 1093210-01)
- Interfaces: EnDat + 1 V_{PP}, EnDat + TTL, EnDat + HTL (via signal adapter ID 1093210-01)
- Display functions: see "Encoder diagnostics", Page 53

Basic firmware 3.0.x does not support the following:

- USB port
- External functions via mini-DIN connection X2

i On incremental encoders with Fanuc, Mitsubishi, Panasonic, or Yaskawa interfaces, limitations of the test and display functions may result, depending on the encoder.

i The above-stated ID number is the number on the ID label. The ID number on the packaging label may differ from the ID number on the ID label because the product can be delivered in different packaging units.

The ID label is provided on the back of the product.

Example:

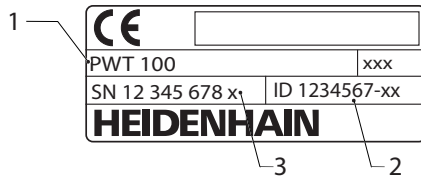

- 1 Product designation
- 2 ID number
- 3 Index

Connection technology

In order to ensure a reliable and correct transmission of the data from the encoder to the product, the connecting cables for the Mitsubishi, Panasonic and Yaskawa interfaces must be designed such that "two-pair transmission" is possible.

If this is not the case, any adapter cables or extension cables being used must be disconnected. A suitable adapter cable must then be used for the connection to the encoder.



For more information, please refer to the Product Information or the Mounting Instructions for the encoder, or the "Interfaces of HEIDENHAIN Encoders" brochure.

Before using the documentation and the product, you need to verify that the documentation matches the product.

- ▶ Compare the ID number and the index indicated in the documentation with the corresponding data given on the ID label of the product
- ▶ Compare the firmware version given in the documentation with the firmware version of the product
- > If the ID numbers and indexes as well as the firmware versions match, the documentation is valid



If the ID numbers and indexes do not match, so that the documentation is not valid, you will find the current documentation for the product at www.heidenhain.com.

1.3 Notes on reading the documentation

WARNING

Fatal accidents, personal injury or property damage caused by non-compliance with the documentation!

Failure to comply with the documentation may result in fatal accidents, personal injury or property damage.

- ▶ Read the documentation carefully from beginning to end
- ▶ Keep the documentation for future reference

The table below lists the components of the documentation in the order of priority for reading.

Documentation	Description
Addendum	An addendum supplements or supersedes the corresponding contents of the Operating Instructions and, if applicable, of the Installation Instructions. If an addendum is included in the shipment, it has the highest priority for reading. All other contents of the documentation retain their validity.
Installation Instructions	The Installation Instructions contain all of the information and safety precautions needed for the proper mounting and installation of the product. The Installation Instructions are contained as an excerpt from the Operating Instructions in every delivery. The Installation Instructions have the second highest level of priority for reading.
Operating Instructions	The Operating Instructions contain all the information and safety precautions needed for the proper operation of the product according to its intended use. The Operating Instructions are included on the supplied storage medium and can also be downloaded in the download area from www.heidenhain.com . The Operating Instructions must be read before the unit is put into service. The Operating Instructions have the third highest level of priority for reading.

Have you found any errors or would you like to suggest changes?

We continuously strive to improve our documentation for you. Please help us by sending your suggestions to the following e-mail address:

userdoc@heidenhain.de

1.4 Storage and distribution of the documentation

The instructions must be kept in the immediate vicinity of the workplace and must be available to all personnel at all times. The operating company must inform the personnel where these instructions are kept. If the instructions have become illegible, the operating company must obtain a new copy from the manufacturer.

If the product is given or resold to any other party, the following documents must be passed on to the new owner:

- Addendum (if supplied)
- Installation Instructions
- Operating Instructions

1.5 Target groups for the instructions

These instructions must be read and observed by every person who performs any of the following tasks:

- Mounting
- Installation
- Operation
- Service, cleaning and maintenance
- Troubleshooting
- Removal and disposal

1.6 Notes in this documentation

Safety precautions

Precautionary statements warn of hazards in handling the device and provide information on their prevention. Precautionary statements are classified by hazard severity and divided into the following groups:

DANGER

Danger indicates hazards for persons. If you do not follow the avoidance instructions, the hazard **will result in death or severe injury**.

WARNING

Warning indicates hazards for persons. If you do not follow the avoidance instructions, the hazard **could result in death or serious injury**.

CAUTION

Caution indicates hazards for persons. If you do not follow the avoidance instructions, the hazard **could result in minor or moderate injury**.

NOTICE

Notice indicates danger to material or data. If you do not follow the avoidance instructions, the hazard **could result in property damage**.

Informational notes

Informational notes ensure reliable and efficient operation of the device.
Informational notes are divided into the following groups:



The information symbol indicates a **tip**.
A tip provides additional or supplementary information.



The gear symbol indicates that the function described **depends on the machine**, e.g.

- Your machine must feature a certain software or hardware option
- The behavior of the functions depends on the configurable machine settings



The book symbol represents a **cross reference** to external documentation, e.g. the documentation of your machine tool builder or other supplier.

1.7 Symbols and fonts used for marking text

In these instructions the following symbols and fonts are used for marking text:

Format	Meaning
▶ ... > ...	Identifies an action and the result of this action Example: ▶ Tap OK > The message is closed
■ ... ■ ...	Identifies an item of a list Example: ■ TTL interface ■ EnDat interface ■ ...
Bold	Identifies menus, displays and buttons Example: ▶ Tap Shut down > The operating system shuts down ▶ Turn the power switch off

2

Safety

2.1 General safety precautions

General accepted safety precautions, in particular the applicable precautions relating to the handling of live electrical equipment, must be followed when operating the system. Failure to observe these safety precautions may result in personal injury or damage to the device.

It is understood that safety rules within individual companies vary. If a conflict exists between the material contained in these instructions and the rules of a company using this system, the more stringent rules take precedence.

2.2 Intended use

The product must only be operated when in proper and safe condition. It is intended solely for the following use:

- Diagnostics and adjustment of HEIDENHAIN encoders with absolute and incremental interfaces
- Diagnostics and adjustment of HEIDENHAIN Corporate Group encoders with absolute or incremental interfaces

Any other use or additional use of the product is considered improper use and can result in damage and hazards.



The product supports the use of a wide variety of peripheral devices from different manufacturers. HEIDENHAIN cannot make any statements on the intended use of these devices. The information on their intended use, which is provided in the respective documentation, must be observed. If no such information has been supplied, it must be requested from the manufacturers concerned.

2.3 Improper use

Any use not specified in 'Intended use' is considered improper use. The company operating the device is solely liable for any damage resulting from improper use.

In particular, the following uses are not permitted:

- Use with parts, cables or connections that are defective or do not comply with the applicable standards
- Use outdoors, or in potentially explosive environments or fire risk areas
- Use outside the operating conditions specified in "Specifications"
- Any alterations of the product or peripherals that have not been authorized by the manufacturers
- Use as a part of a safety function

2.4 Personnel qualification

Mounting, installation, operation, maintenance, and disassembly must be done by a qualified service technician. The service technician must have obtained sufficient information from the documentation supplied with the product and with the connected peripherals.

The service technician uses and operates the device within the framework specified for the intended use. The service technician has been specially trained for the environment he or she works in. The service technician has the required technical training, knowledge and experience and is familiar with the applicable standards and regulations, and is thus capable of performing the assigned work regarding the application concerned and of proactively identifying and avoiding potential risks. He or she must comply with the provisions of the applicable legal regulations on accident prevention.

2.5 Obligations of the operating company

The operating company owns or leases the device and the peripherals. At all times, the operating company is responsible for ensuring that the intended use is complied with.

The operating company must:

- Assign the different tasks to be performed on the device to suitable, qualified and authorized personnel
- Verifiably train the personnel in the authorizations and tasks
- Provide all materials and means necessary in order for the personnel to complete the assigned tasks
- Ensure that the device is operated only when in perfect technical condition
- Ensure that the device is protected from unauthorized use

2.6 General safety precautions



The safety of any system incorporating the use of this product is the responsibility of the assembler or installer of the system.





The product supports the use of a wide variety of peripheral devices from different manufacturers. HEIDENHAIN cannot make any statements on the specific safety precautions to be taken for these devices. The safety precautions provided in the respective documentation must be observed. If there is no documentation at hand, it must be obtained from the manufacturers concerned.

The specific safety precautions required for the individual activities to be performed on the product are indicated in the respective sections of these instructions.

2.6.1 Symbols on the product

The following symbols are used to identify the product:

Symbol	Meaning
	Observe the safety precautions regarding electricity and power connection before you connect the product.
	Functional ground connection as per IEC/EN 60204-1. Observe the information on installation.
	Product seal. Breaking or removing the product seal will result in forfeiture of warranty and guarantee.

2.6.2 Electrical safety precautions

WARNING

Hazard of contact with live parts when opening the wall adapter power supply.

This may result in electric shock, burns or death.

- ▶ Never open the housing
- ▶ Only the manufacturer is permitted to access the inside of the product

WARNING

Hazard of dangerous amount of electricity passing through the human body upon direct or indirect contact with live electrical parts.

This may result in electric shock, burns or death.

- ▶ Work on the electrical system and live electrical components is to be performed only by trained specialists
- ▶ For power connection and all interface connections, use only cables and connectors that comply with applicable standards
- ▶ Have the manufacturer exchange defective electrical components immediately
- ▶ Regularly inspect all connected cables and all connections on the product. Defects, such as loose connections or scorched cables, must be removed immediately

NOTICE

Damage to internal parts of the product!

If you open the product, the warranty and the guarantee will become void.

- ▶ Never open the housing
- ▶ Only the product manufacturer is permitted to access the inside of the product

2.6.3 Safety precautions for operation with and in numerically controlled machines

DANGER

Serious personal injury or property damage caused by improper use of the NC!

Improper use caused by incorrect operation of the NC, incorrect NC programming, incorrect or non-optimized machine parameter values

- ▶ Acquire fundamental knowledge about machine, servo drives, inverters and NCs as well as their interaction with the encoders so that faulty behavior of a numerically controlled machine can be assessed correctly
- ▶ Apart from the information in these instructions, observe the specific safety regulations and accident prevention regulations when handling the respective machines, servo drives, inverters, and NCs
- ▶ When the product is installed in a machine or used in other special applications, all safety precautions detailed in these instructions must be adapted to the respective conditions of use
- ▶ Comply particularly with the required adaptations to changed grounding situations during installation and during connection of the product to the control loop of a numerically controlled machine
- ▶ The machine manufacturer must be contacted for fault diagnosis

3

**Transport and
storage**

3.1 Overview

This chapter contains information on the transportation and storage of the product and provides an overview of the items supplied and the available accessories for the product.



The following steps must be performed only by qualified personnel.

Further information: "Personnel qualification", Page 19

3.2 Unpacking

- ▶ Open the top lid of the box
- ▶ Remove the packaging materials
- ▶ Unpack the contents
- ▶ Open the case or packaging box



PWT 100/PWT 101 is shipped in a case or packaging box.

- ▶ Check the delivery for completeness
- ▶ Check the delivery for damage

3.3 Items supplied and accessories

The following items are included in delivery:

- Device
- Installation Instructions
- Addendum (optional)
 - ▶ **Further information:** "Notes on reading the documentation", Page 12
- Wall adapter power supply with connecting cable, adapter for power connection

The items supplied are shipped in a case or packaging box.

3.4 In case of damage in transit

- ▶ Have the shipping agent confirm the damage
- ▶ Keep the packaging materials for inspection
- ▶ Notify the sender of the damage
- ▶ Contact the distributor or machine manufacturer for replacement parts



If damage occurred during transit:

- ▶ Keep the packaging materials for inspection
- ▶ Contact HEIDENHAIN or the machine manufacturer

This applies also if damage occurred to requested replacement parts during transit.

3.5 Repackaging and storage

Repackage and store the product carefully in accordance with the conditions stated below.

3.5.1 Repackaging the product

Repackaging should correspond to the original packaging as closely as possible.

- ▶ Re-attach all mounting parts and dust protection caps to the product as received from the factory, or repackage them in the original packaging as received from the factory
- ▶ Repackage the product in such a way that
 - it is protected from impact and vibration during transit
 - it is protected from the ingress of dust or humidity
- ▶ Place all accessories that were included in the shipment in the original packaging
Further information: "Items supplied and accessories", Page 24
- ▶ Enclose all the documentation that was included in the original packaging
Further information: "Storage and distribution of the documentation", Page 13



If the product is returned for repair to the Service department:

- ▶ Ship the product without accessories, without encoders and without peripherals

3.5.2 Storage of the product

- ▶ Package the product as described above
- ▶ Observe the specified ambient conditions
Further information: "Specifications", Page 153
- ▶ Inspect the product for damage after any transport or longer storage times

4

Mounting

4.1 Overview

This chapter describes the mounting of the product.



The following steps must be performed only by qualified personnel.

Further information: "Personnel qualification", Page 19

4.2 Mounting location

NOTICE

Impaired functions or damage to the product caused by improper mounting location!

Choosing an improper mounting location may impair the functions of the product or may cause damage to the product.

- ▶ Select the mounting location such that the product may be easily accessed during operation
- ▶ Ensure proper ventilation

Mounting the product

Ensure that the product is properly mounted before you start using it:

- ▶ Place the product with the rear panel facing down so that the display faces upwards

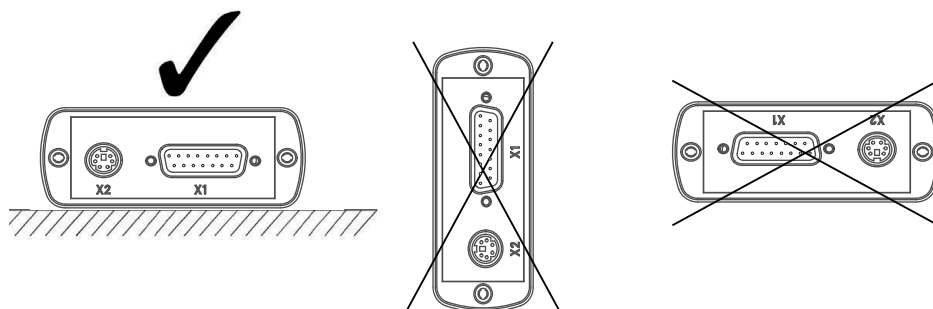

5

Installation

5.1 Overview

This chapter contains all the information necessary for installing the device.



The following steps must be performed only by qualified personnel.

Further information: "Personnel qualification", Page 19

5.2 General information

NOTICE

Interference from sources of high electromagnetic emission!

Peripheral devices, such as frequency inverters or servo drives, may cause interference.

- ▶ To increase the noise immunity to electromagnetic influences, use the optional functional ground connection as per IEC/EN 60204-1

NOTICE

Engaging and disengaging connecting elements!

Risk of damage to internal components.

- ▶ Do not engage or disengage any connecting elements while the device is under power

NOTICE

Electrostatic discharge (ESD)!

This device contains electrostatic sensitive components that can be destroyed by electrostatic discharge (ESD).

- ▶ It is essential to observe the safety precautions for handling ESD-sensitive components
- ▶ Never touch connector pins without ensuring proper grounding
- ▶ Wear a grounded ESD wristband when handling device connections

5.3 Device overview

Left side panel

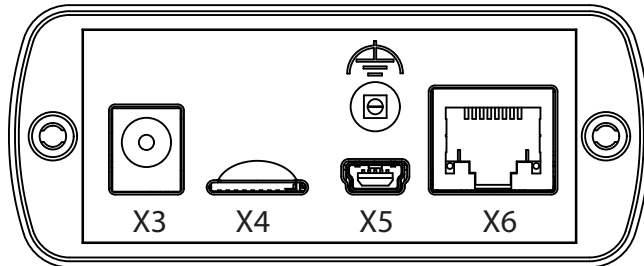

- X3** Connection for wall adapter power supply
- X4** Slot for microSD memory card
- X5** USB 2.0 Type mini B, female (data interface)
- X6** 8+2-pin RJ45 connection for encoders with DRIVE-CLiQ interface
-  Functional ground (socket, diameter 2 mm)

Right side panel

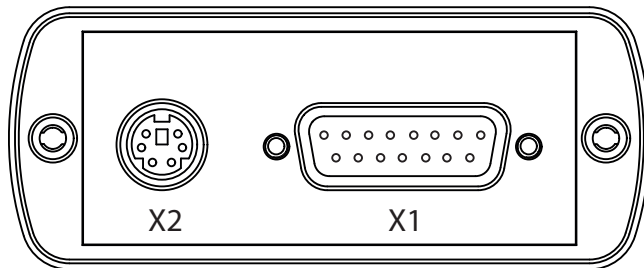

- X2** 6-pin mini-DIN connection for external functions
- X1** 15-pin D-sub input for HEIDENHAIN encoders with:
 - 11 μA_{PP} interface
 - 1 V_{PP} interface
 - TTL interface
 - HTL/HTLs interface (via signal adapter 1093210-01)
 - EnDat interface
 - Interface for:
 - Fanuc
 - Mitsubishi
 - Panasonic
 - Yaskawa

5.4 Connecting the product

⚠ DANGER

Risk of electric shock!

Improper grounding of electrical devices may result in serious personal injury or death.

- ▶ Use only the wall adapter power supply included in delivery or a unit that has been certified by the manufacturer

⚠ WARNING

Danger of fire!

Use of wall adapter power supplies that do not meet the minimum requirements!

- ▶ Use only wall adapter power supplies that fulfill or exceed the specified minimum requirements.
- ▶ Connect the functional ground of the product with the corresponding connection of the system
($R \ll 1 \text{ ohm}$)
- ▶ Select the correct adapter for your power supply system from the items supplied
- ▶ Place the adapter onto the wall adapter power supply and slide it into the power supply until a click is heard and the adapter is locked in place
- ▶ Connect the connector of the wall adapter power supply to connection X3 on the left side panel of the product
- ▶ Connect the wall adapter power supply to the power outlet
- > The line voltage is connected, and the product is ready for operation

Replacing the adapter

- ▶ Disconnect the wall adapter power supply from line power and from the product
- ▶ Press and hold the button on the bottom side of the wall adapter power supply
- ▶ Remove the old adapter by sliding it away from the wall adapter power supply and pulling it off
- ▶ Place the new adapter onto the wall adapter power supply and slide it into the power supply until a click is heard and the adapter is locked in place

Pin layout of X3

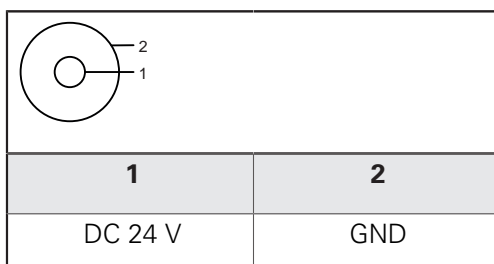

5.5 Connecting encoders

NOTICE

Damage to the product and the encoder caused by incorrect voltage supply range or incorrect wiring!

An incorrect voltage supply range or incorrect wiring / pin layout may cause damage to the product and the encoder.

- ▶ Note the voltage supply range of the connected encoder
- ▶ Verify that the connecting cable between the encoder and the product is correctly wired
- ▶ Vacant pins or wires must not be used
- ▶ Do not engage or disengage the connecting cable between the encoder and the product while under power
- ▶ The connection of non-HEIDENHAIN encoders to the product and the operation of the product with non-HEIDENHAIN encoders are at the user's own risk

Connections

- Encoders with a 15-pin D-sub interface are connected to encoder input X1 on the right side panel of the product.
- Encoders with 8+2-pin DRIVE-CLiQ interface are connected to encoder input X6 on the left side panel of the product.

Further information: "Device overview", Page 31

i An encoder must be connected only to encoder input X1 or to encoder input X6. You must not connect an encoder to more than one of the two inputs at any one time.

The pin layouts of the connecting cables are described in the brochure.

i Information on the signal assignment of the pins in the annex:

- Cable shield connected to housing
- U_P = Power supply
- Sense: The sense lines are used for the function of readjusting the power supply (remote sense control).

EnDat interface

Pin	Function
1, 3, 7, 9, 11, 14	Incremental signals (only with ordering designations EnDat 01 and EnDat 02)
2, 4, 10, 12	Power supply
5, 8, 13, 15	Serial data transfer
6	Internal shield

For signal assignment of EnDat, see "F," Page 35

Interface for Fanuc, Mitsubishi, Yaskawa, or Panasonic

Pin	Function
1, 3, 7, 9, 11, 14	Incremental signals (if available, only for adjusting; do not use in normal operation)
2, 4, 10, 12	Power supply
5, 8, 13, 15	Serial data transfer
6	/

For signal assignment of Fanuc, see "G," Page 35.

For signal assignment of Mitsubishi, see "H," Page 35.

For signal assignment of Yaskawa and Panasonic, see "I," Page 35.



Fanuc and Mitsubishi: Do not use pins 5 and 13 for one-pair transmission.

DRIVE-CLiQ interface

Pin	Function
A, B	Power supply
1, 2, 3, 6	Serial data transfer

For the signal assignment of DRIVE-CLiQ, see "P," Page 36.

1 V_{PP} interface (1 V_{PP}/Z1, 1 V_{PP} with limit positions, 1 V_{PP} with clock/data)

Pin	Function
1, 3, 7, 9, 11, 14	Incremental signals
2, 4, 10, 12	Power supply
5, 6, 8, 13, 15	Other device-dependent signals (switched internally)

For signal assignment of 1 V_{PP} with limit positions, see "J," Page 35.

For signal assignment of 1 V_{PP}/Z1, see "K," Page 35.

For signal assignment of 1 V_{PP} with clock/data, see "L," Page 35.

11 μA_{PP} interface

Pin	Function
1, 3, 7, 9, 11, 14	Incremental signals
2, 4	Power supply
5, 8, 10, 12, 13, 15	/
6	Internal shield

For signal assignment of 11 μA_{PP}, see "M," Page 35.

TTL interface

Pin	Function
1, 3, 7, 9, 11, 14	Incremental signals
2, 4, 10, 12	Power supply
5	/
6, 8	Limit signals (if supported by the encoder)
13	Fault-detection signal
15	PWT test pulse (if supported by the encoder)

For TTL signal assignment, see "N," Page 35.

Pin layout of X1

	1	2	3	4	5	6	7	8	9	10	11	12	13	14	15
F	A+	0 V	B+	U _P	Data	Internal shield	/	Clock	A-	Sensor 0 V	B-	Sensor U _P	Data	/	Clock
G	A+	0 V	B+	U _P	Serial Data	/	R-	Request	A-	Sensor 0 V	B-	Sensor U _P	Serial Data	R+	Request
H	A+	0 V	B+	U _P	Serial Data	/	R-	Request Frame	A-	Sensor 0 V	B-	Sensor U _P	Serial Data	R+	Request Frame
I	A+	0 V	B+	U _P	/	/	R-	Data	A-	Sensor 0 V	B-	Sensor U _P	/	R+	Data
J	A+	0 V	B+	U _P	/	L2	R-	L1	A-	Sensor 0 V	B-	Sensor U _P	/	R+	/
K	A+	0 V	B+	U _P	C+	Internal shield	R-	D-	A-	Sensor 0 V	B-	Sensor U _P	C-	R+	D+
L	A+	0 V	B+	U _P	Test	/	R-	/	A-	Sensor 0 V	B-	Sensor U _P	Clock	R+	Data
M	I ₁₊	0 V	I ₂₊	U _P	/	Internal shield	I ₀₋	/	I ₁₋	/	I ₂₋	/	/	I ₀₊	/
N	U _{a1}	0 V	U _{a2}	U _P	/	L2	U _{a0}	L1	U _{a1}	Sensor 0 V	U _{a2}	Sensor U _P	U _{aS}	U _{a0}	PWT Test Pulse

DRIVE-CLiQ**Pin layout of X6**

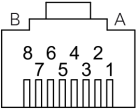
									
1	2	3	4	5	6	7	8	A	B
TXP	TXN	RXP	/	/	RXN	/	/	U _P	M (0 V)

Connecting the encoder cables**NOTICE****Damage to the product and the encoder caused by incorrect voltage supply range or incorrect wiring!**

An incorrect voltage supply range or incorrect wiring / pin layout may cause damage to the product and the encoder.

- ▶ Note the voltage supply range of the connected encoder
 - ▶ Verify that the connecting cable between the encoder and the product is correctly wired
 - ▶ Vacant pins or wires must not be used
 - ▶ Do not engage or disengage the connecting cable between the encoder and the product while under power
 - ▶ The connection of non-HEIDENHAIN encoders to the product and the operation of the product with non-HEIDENHAIN encoders are at the user's own risk
-
- ▶ Connect the encoder cables to the respective connections
 - ▶ If the cable connectors include mounting screws, do not overtighten them
 - ▶ Do not subject the plug connections to mechanical load

5.6 Connecting a computer

A computer can be connected to the X5 USB connection (Type Mini-B) via the computer's USB 2.0 High-Speed interface.

The functions supported via the USB connection depend on the firmware version being used.

- ▶ Connect the USB interface of the computer to connection X5 via a USB cable

Further information: "Device overview", Page 31.

Pin layout of X5

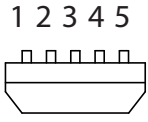
				
1	2	3	4	5
5 V DC	Data (-)	Data (+)	/	GND

5.7 Connecting an external device

An external device with a 6-pin mini-DIN connection can be connected to connection X2.

The functions supported via the mini-DIN connection vary depending on the firmware version being used.

- ▶ Use a standard cable with a 6-pin mini-DIN connector to connect the mini-DIN connection of the external device to connection X2

Further information: "Device overview", Page 31.

Pin layout of X2

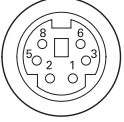
					
1	2	3	5	6	8
Out A2	Out A1	In	In/Out IO1	In/Out IO2	GND

6

Basic operation

6.1 Overview

This chapter describes the product's operating elements and user interface as well as its basic functions.

The product is operated solely by touchscreen.

6.2 Menus and screens

The product features various menus. Tapping a menu opens various views.

Main menu (opening screen)

The user interface of the product provides a main menu with menus for the individual product functions.

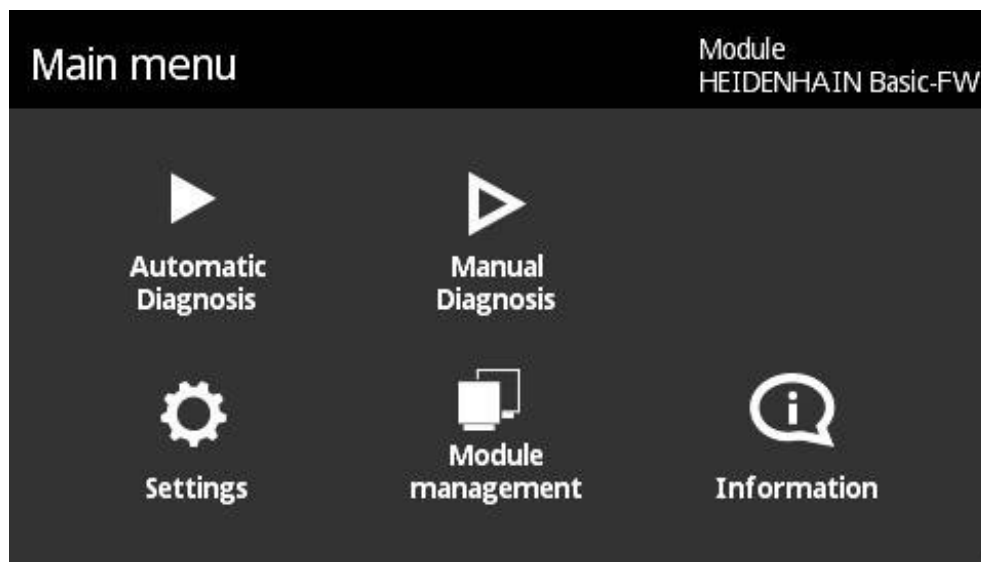

Figure 1: Main menu

Screens

The menu functions within the individual menus are spread over several screens. You switch between the screens within a menu by swiping the menu screen from right to left or from left to right.

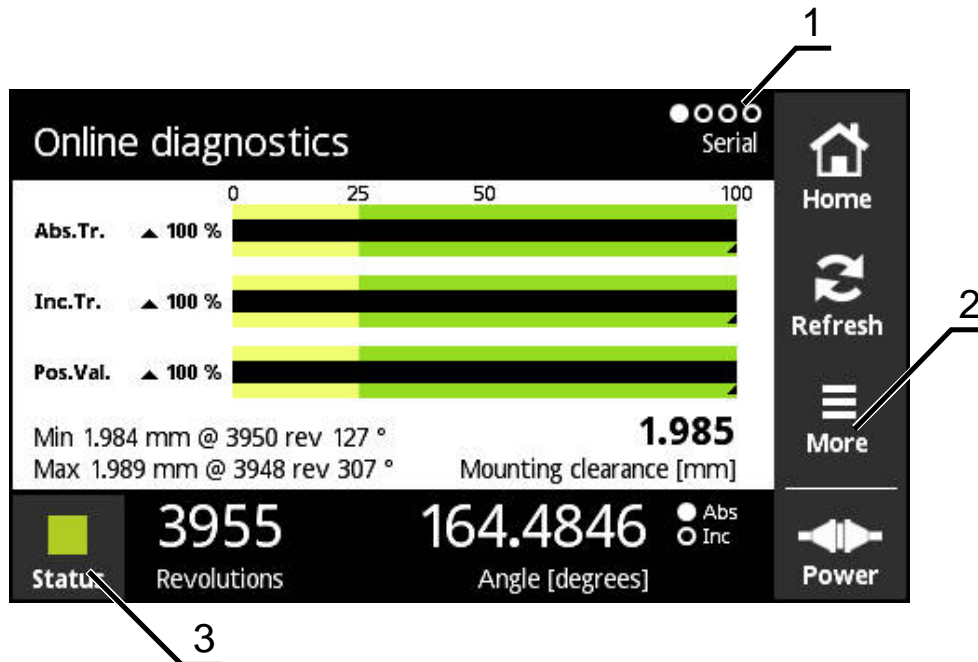



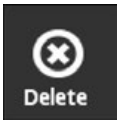







Figure 2: Screen of a menu

- 1 Number of available screens within a menu
- 2 Menu **More**
- 3 Status button

6.3 Operating elements

The following table shows the operating elements that are used in various menus and screens of the product.

Operating element	Function
 Home	<p>Home Opens the Main menu (opening screen)</p> <div style="border: 1px solid black; padding: 5px;"> <p> In the Main menu, the supply voltage for the connected encoder can be switched off.</p> </div>
 Refresh	<p>Refresh Resets the current displays on the screen</p>
 Delete	<p>Delete Resets error messages</p>
 More	<p>More Opens the More menu with additional functions</p>
 Back	<p>Back Moves up one menu level</p>
 Power	<p>Power</p> <ul style="list-style-type: none"> ■ Indicates the power supply of the encoder (active/inactive) ■ Opens the Encoder supply screen when the power supply is active
 Power	
 Progress indicator	<p>Indicates the number of available screens within a menu</p> <ul style="list-style-type: none"> ■ Indicates the number of available screens within a menu level ■ Indicates the position of the current screen within a menu level

6.4 Gestures

Tap

Tapping is touching the screen briefly with your finger tip

The actions initiated by tapping include:

- Select a menu
- Execute function



Swiping

Swiping is sliding a finger across the touchscreen with no defined start or end point of motion.

The actions initiated by swiping across the touchscreen include:

- Swiping left to right (or vice versa): Switch the screen within a menu level
- Swiping up or down: Scroll within a screen

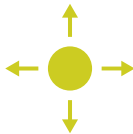

Holding with three fingers

Holding is touching the screen and holding your finger(s) on it.

Holding with three fingers initiates the following action:

- Create a screenshot and save it to the memory card



6.5 On-screen keyboard

With the on-screen keyboard, you can enter text into the input fields of the user interface.

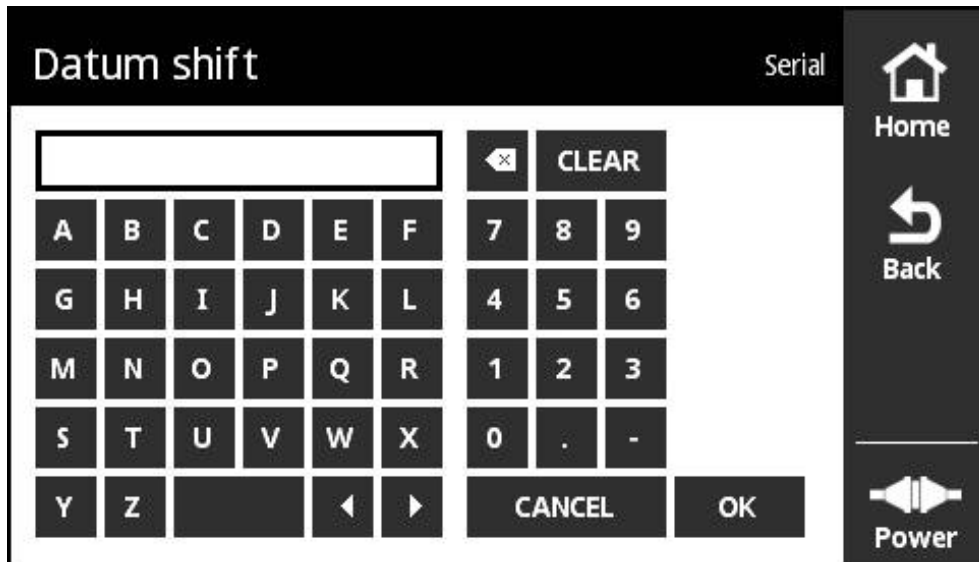

Figure 3: On-screen keyboard (example: **Datum shift**)

- ▶ To enter values, tap an input field
- > The on-screen keyboard is opened
- ▶ Enter text or numbers
- ▶ Confirm the entry with **OK** for the values to take effect
- > The on-screen keyboard is closed
- > The value entered appears in the input field

6.6 Switch-on/Switch-off

Switching on the product

The product is switched on as soon as you connect the power plug to the power outlet. The product is switched off by disconnecting it from the power source.

The product can be switched on when an encoder is connected to it or when no encoder is connected to it.

 Verify that the encoder is connected correctly to the product before you switch it on.

- ▶ Connect the connector of the wall adapter power supply to connection X3 on the left side panel of the product
- ▶ Connect the wall adapter power supply to the power outlet
- > The product starts up
- > A warning is displayed on the product's screen

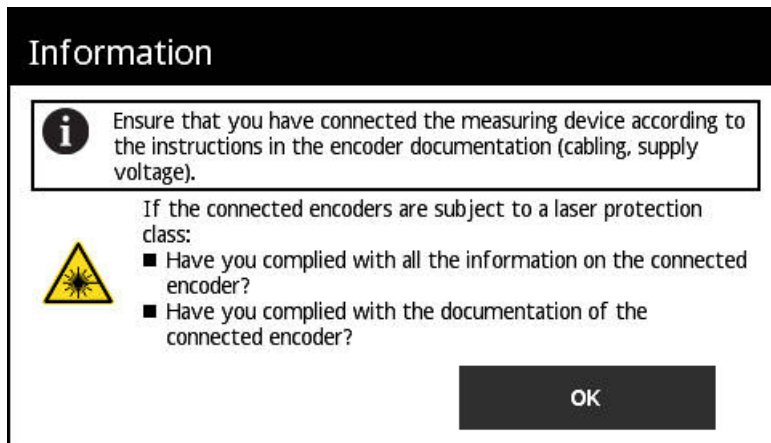

Figure 4: Warning during start-up process

- ▶ Tap **OK**
- > The **Main menu** is opened

Switching off the product

- ▶ Disconnect the wall adapter power supply from the power outlet
- ▶ Disconnect the connector of the wall adapter power supply from connection X3 on the left side panel of the product
- > The product is disconnected from the power source and switched off

6.7 Setting the language

The default language for the user interface is English.



- ▶ Tap **Settings** in the **Main menu**
- > The **Language settings** screen is opened
- ▶ Tap the appropriate flag for the desired language
- > The **Language changed** message is displayed
- ▶ Tap **OK**
- > The user interface is displayed in the selected language

6.8 Creating a screenshot

You can take a screenshot in every screen. The screenshots are saved to the memory card inserted.



- ▶ Open the desired screen
- ▶ On the screen: Hold with three fingers
- > The message **Screenshot created** is displayed
- ▶ Confirm with **OK**
- > The screenshot is saved to the memory card as a file (*.bmp)



You have various options of setting screenshot designations. **Further information:** "General settings screen", Page 125



In order to view the screenshots saved on the memory card, you need to remove the memory card from the product and use a card reader to transfer the files.

6.9 Power supply of the encoder

Power displays the current status of the power supply between the product and the connected encoder.

Display	Function
	Power supply between the product and the connected encoder is active
	Power supply between the product and the connected encoder is inactive

Tap **Power** to open the **Encoder supply** screen.

The **Encoder supply** screen displays the status and measured values of the power supply between the product and the connected encoder.

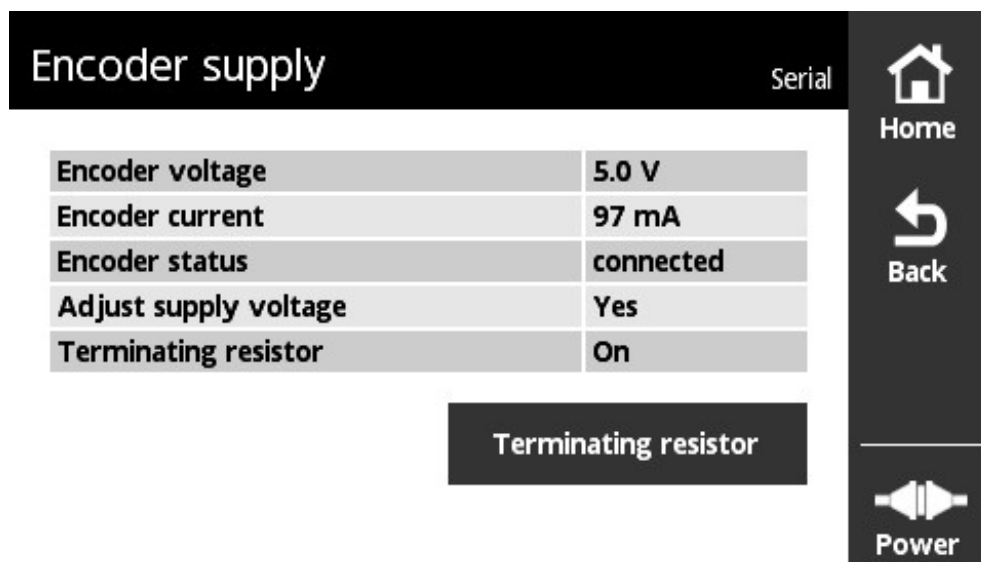

Figure 5: **Encoder supply** screen

Activating or deactivating the terminating resistor

You can activate or deactivate the terminating resistor on the product depending on the interface. The availability of a terminating resistor depends on the respective interface.

If you deactivate the terminating resistor, you can read off the typical current consumption of encoders. Switching the terminating resistors leads to temporary activation/deactivation. When you close the **Encoder supply** screen again, the status of the terminating resistor is reset.



- ▶ Tap **Power**
- The **Encoder supply** screen is opened
- ▶ Tap **Terminating resistor**
- The product shows the status and the current change in the table

Disconnecting the power supply of the encoder

You can disconnect the power supply of the encoder in any screen.



- ▶ Tap **Home**
- > The power supply of the encoder is disconnected
- > The **Main menu** is displayed

7

Main menu

7.1 Overview

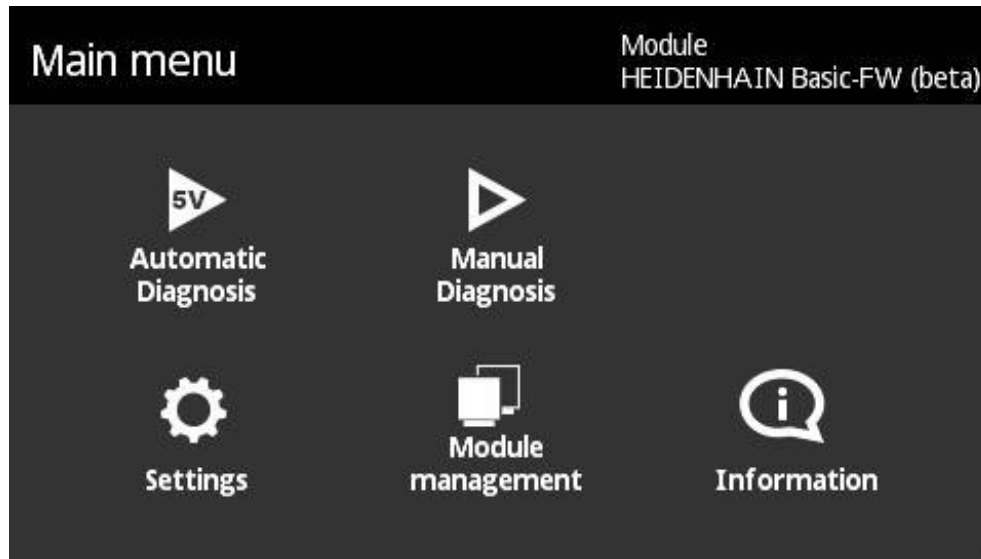

Figure 6: Main menu



If the product displays the main menu, the power supply to the encoder is off.

The main menu of the product provides the following menus:

Operating element	Function
	The Automatic Diagnosis menu enables you to analyze and evaluate the connected encoder. The product tries to automatically identify the connected encoder interface. Further information: "Encoder diagnostics", Page 53
	The Manual Diagnosis menu enables you to manually set the encoder interface if the product does not automatically identify the encoder interface. Further information: "Encoder diagnostics", Page 53
	The Settings menu enables you to select the user interface language, change the unit of the measured temperature and make settings for screenshots. You can adjust the brightness of the display and restart the product. Further information: "Settings menu", Page 123
	In the Module management menu, you manage the product's basic firmware and supplementary modules. Further information: "Module management menu", Page 129
	The Information menu provides general information on the power supply of the product, the module version and hardware version, as well as license information. Further information: "Information menu", Page 137

7.2 Opening the Main menu

You can switch from any of the product's menu screens to the main menu by using the **Home** button.



- ▶ Tap the **Home** button
- > The **Main menu** is opened

8

**Encoder
diagnostics**

8.1 Various diagnostics screens

The product provides the following options for encoder diagnostics:

- If the **Automatic Diagnosis** menu is used, the product tries to automatically identify the encoder interface and run the appropriate diagnosis.
Further information: "Performing Automatic Diagnosis", Page 55
- The **Manual Diagnosis** menu enables you to manually set the encoder interface (for example, if the product does not automatically identify the encoder interface).
Further information: "Performing Manual Diagnosis", Page 56

In both cases the device shows different views during the diagnosis, depending on the encoder interface. The screens automatically adapt to the respective encoder function. The screens available in each case are shown in the following chart.

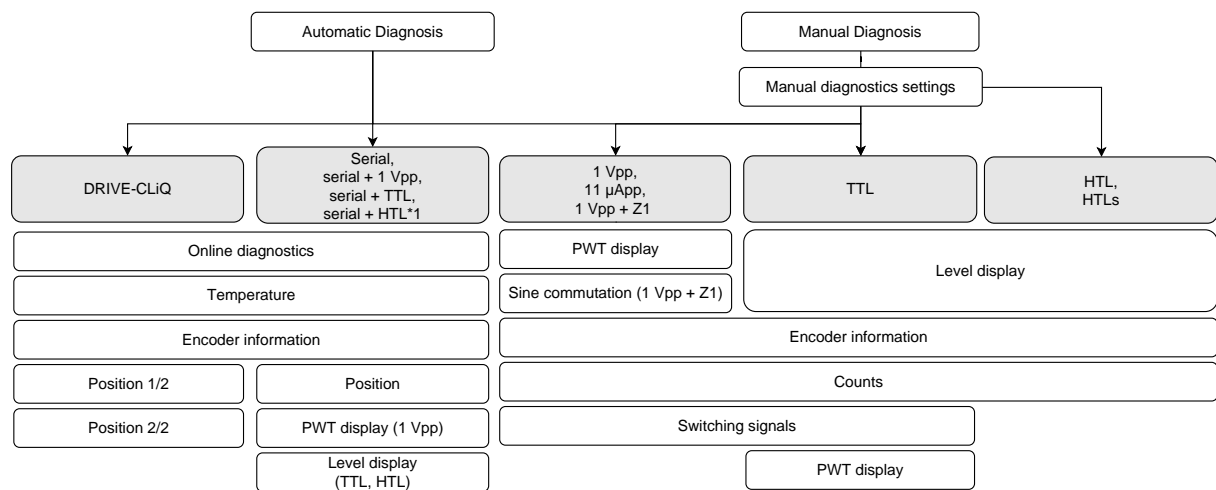

(*1 only via **Manual Diagnosis**)



If the **Automatic Diagnosis** does not identify an encoder correctly, you have to connect the encoder via the **Manual Diagnosis** menu.

8.2 Performing Automatic Diagnosis

If the **Automatic Diagnosis** menu is used, the product tries to automatically identify the encoder interface and run the appropriate diagnosis.

The following procedure is used for the automatic diagnosis:

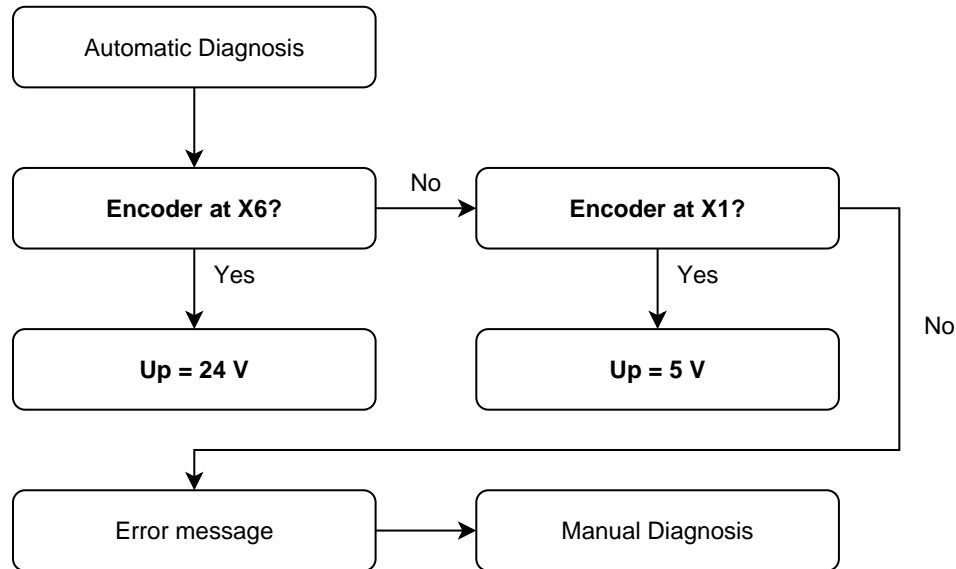

- ▶ Tap **Automatic Diagnosis**
- The **Automatic Diagnosis** is performed and, depending on the encoder interface, shows the **PWT display**, **Online diagnostics** or **Level display** screen



The power supply at X6 is always set to $U_p = 24\text{ V}$.
 The power supply at X1 is always set to $U_p = 5\text{ V}$.
 If you connect an encoder with a different supply voltage, you have to use the **Manual diagnostics**
Further information: "Performing Manual Diagnosis", Page 56



If no encoder is connected to the product or if there are signal errors, the product displays an error message. In some cases, for example if the signal amplitudes are too low, the **Automatic Diagnosis** cannot clearly identify the interface of the connected encoder. In these cases, the **Manual Diagnosis** has to be called.



The type and number of available screens vary depending on the connected encoder interface.
Further information: "Various diagnostics screens", Page 54

8.3 Performing Manual Diagnosis

The **Manual Diagnosis** menu enables you to manually set the encoder interface (for example, if the product does not automatically identify the encoder interface).



The type and number of available screens vary depending on the connected encoder interface.

Further information: "Various diagnostics screens", Page 54



- ▶ Tap **Manual Diagnosis**
- The **Manual Diagnosis** menu is opened and shows the **Supply voltage of encoder** screen

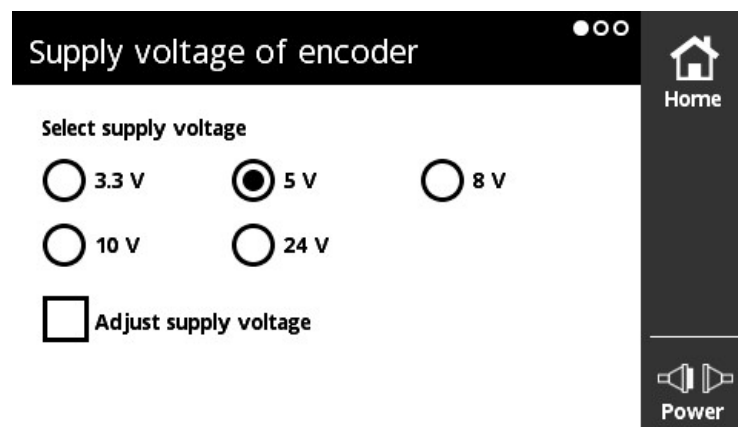

Figure 7: **Supply voltage of encoder** screen

- ▶ Select supply voltage
- ▶ Activate the **Adjust supply voltage** checkbox, if required
- ▶ Swipe right to left
- The **Encoder interface** screen is opened

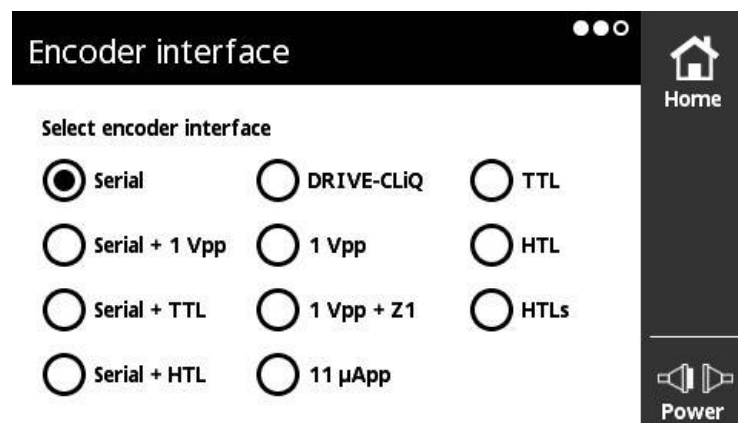

Figure 8: **Encoder interface** screen

- ▶ Select the **Encoder interface**
- ▶ Swipe right to left
- The **Manual diagnostics** screen is opened

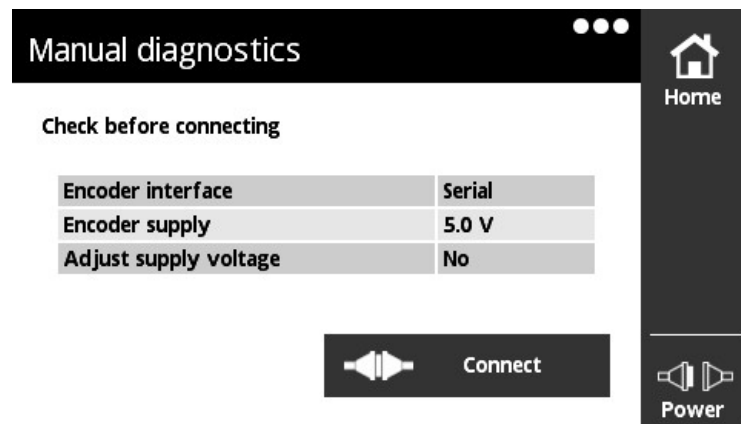

Figure 9: **Manual diagnostics** screen

- ▶ Check your selection
- ▶ Tap **Connect**
- > The diagnosis is opened and, depending on the encoder interface, shows the **PWT display**, **Online diagnostics** or **Level display** screen



If no encoder is connected to the product or if there are signal errors, the product displays an error message.

8.4 Diagnosis for encoders with serial interface

8.4.1 Online diagnostics screen

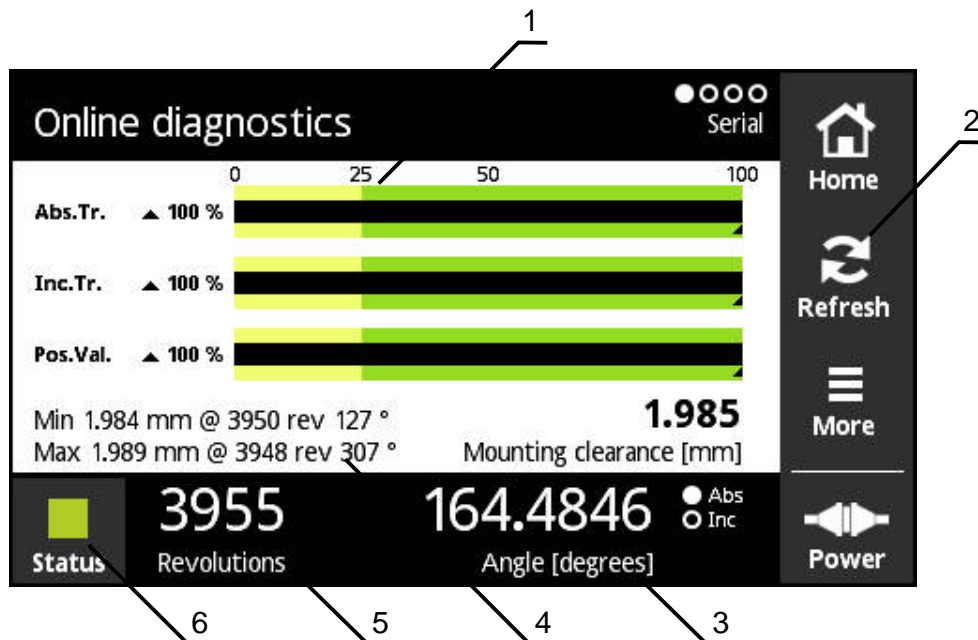

Figure 10: **Online diagnostics** screen

- 1 Status bars
- 2 Reset the minimum values
- 3 Position display
- 4 Mounting clearance
- 5 Revolutions
- 6 Status

The **Online diagnostics** screen uses status bars to display the current diagnostic values of an encoder with serial interface. For the supported interfaces see "Information on the product", Page 10.



The position values are displayed without interpreting any algebraic sign that may be applicable due to the interface definition. On linear encoders, this may lead to the display of high position values. In this case the further analysis of the encoder should be performed with a PWM 21 phase meter and the ATS software. Alternately, you can evaluate the position values based on the position jump at the transition from zero to the maximum value.

KCI support

- * = PWT has calculated the value
- To obtain the value of the correct mating dimensions, a compensation calculation needs to be performed
- For more information, refer to the encoder documentation

Status bars for function reserves

The status bars (1) of the **Online diagnostics** screen show the status of the function reserves. Up to four function reserves are supported, depending on the encoder.

The following function reserves are displayed for absolute encoders with serial interfaces:

- **Abs.Tr.:** Absolute track
- **Inc.Tr.:** Incremental or scanning track
- **Pos.Val.:** Position value calculation

The following function reserves are displayed for incremental encoders with purely serial interfaces:

- **Inc.Tr.:** Incremental or scanning track
- **Ri.Width:** Reference pulse width
- **Ri.Pos.:** Reference pulse position

Display

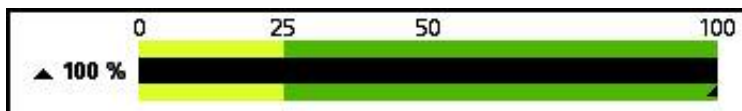

Figure 11: Display of the function reserves

The product displays the function reserves in a bar graph:

- 0 % to 25 %: Yellow range → Servicing/maintenance recommended
- 25 % to 100 %: Green range → The encoder is within the specification



There is a time difference of approx. 10 ms between the calculation of the position and the valuation numbers.

Resetting the minimum values

You can reset the minimum values displayed in the **Online diagnostics** screen.



- ▶ Tap the **Refresh** button
- > The displayed minimum values are reset

Diagnostic values of online diagnostics

Position display

The **Angle [degrees]** (3) position display shows absolute or incremental position values depending on the encoder model.

- **Abs**: Absolute position value
- **Inc**: Incremental position value
 - **Inc** shown in yellow: Reference mark not yet detected
 - **Inc** shown in white: Reference mark detected

Tapping the display opens the **Datum shift** screen.

Further information: "Datum shift screen ", Page 66

Revolutions

Revolutions (5) shows the number of revolutions performed depending on the encoder model.

Tapping the display opens the **Datum shift** screen.

Further information: "Datum shift screen ", Page 66

Status

The **Status** display (6) shows whether there are any messages about the connected encoder.

- Green: There are no messages
- Red: There are messages

Tapping the display opens the **Encoder status** screen.

Further information: "Encoder status screen", Page 70

Mounting clearance

The values shown in **Mounting clearance [mm]** (4) make it easy to verify if the encoder is mounted correctly.

Certain encoders generate values, such as the mounting clearance, that enable you to easily verify if the encoder is mounted correctly. If supported by the encoder, these values are transferred via the interface and displayed by the product in the **Online diagnostics** screen.



For the nominal values of the mounting clearance, refer to the mounting instructions for the respective encoder.

8.4.2 Temperature screen

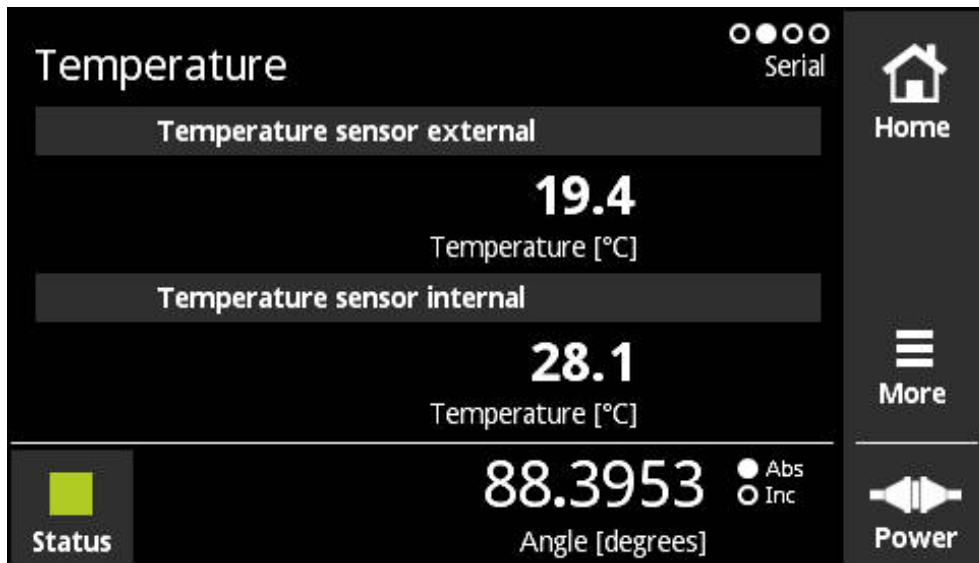

Figure 12: **Temperature** screen

The **Temperature** screen displays the temperature values measured by the internal temperature sensor and the external temperature sensor of the connected encoder.

Precondition: The encoder has an internal temperature sensor as well as an external temperature sensor and supports this function.



If the connected encoder has only one temperature sensor or none at all, the product will display the **Sensor is not supported** message instead of a measured temperature value.

You can change the unit of the measured temperature values. You can select °C or °F.

Further information: "General settings screen", Page 125

8.4.3 Encoder information screen

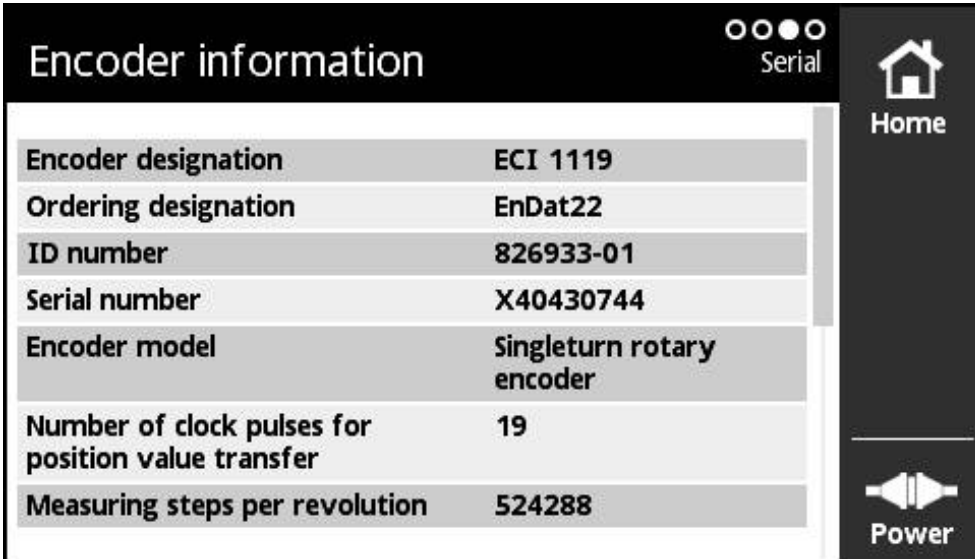

Encoder information	
Encoder designation	ECI 1119
Ordering designation	EnDat22
ID number	826933-01
Serial number	X40430744
Encoder model	Singleturn rotary encoder
Number of clock pulses for position value transfer	19
Measuring steps per revolution	524288

Figure 13: Encoder information screen

The **Encoder information** screen displays information saved about the connected encoder.

Precondition: The encoder supports this function.



The **Encoder information** screen displays only selected information on the connected encoder. This screen does not show the complete memory contents of the encoder.

8.4.4 Position screen

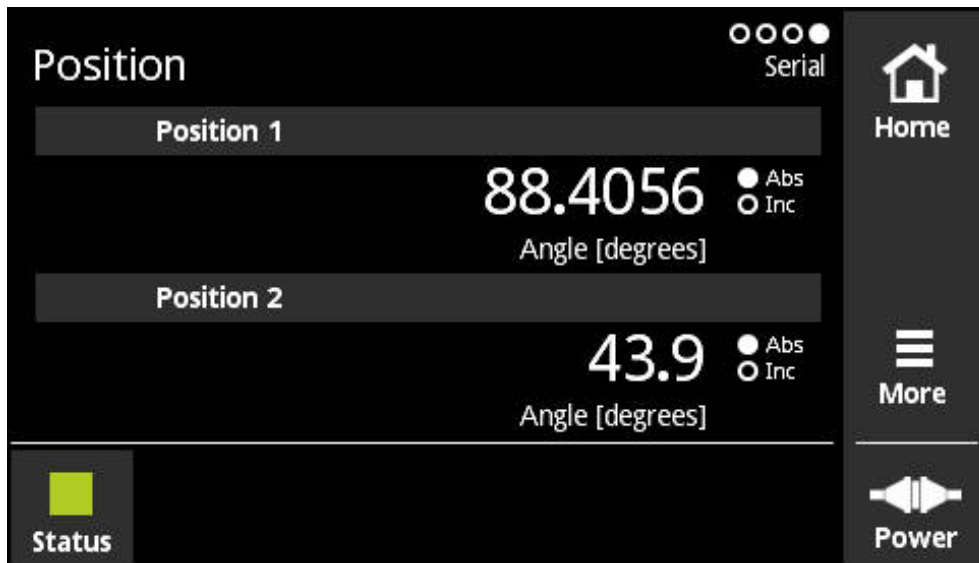

Figure 14: **Position** screen

The **Position** screen displays information about a second position value.

Precondition: The encoder is capable of displaying a second position value and supports this function (e.g. incremental encoders with purely serial interface or encoders that support functional safety).

If the encoder also provides incremental signals, the second position value is generated from the incremental signals. When you call the **Position** screen, the second position is set to the starting value of the first position. From that moment, the second position value is generated on the basis of the incremental signals.

8.4.5 PWT display screen

If the encoder also provides 1 V_{PP} incremental signals, you can evaluate them in the **PWT display** screen. The product automatically shows the **PWT display** screen. This enables you to check functions better. **Further information:** "PWT display screen ", Page 73

i Information like, for example, the units for the count value display in **Angle [degrees]** or **Position [μm]** are read out and set automatically, depending on the encoder type.

8.4.6 Level display screen

If the encoder also provides TTL incremental signals, you can evaluate them in the **Level display** screen. The product automatically shows the **Level display** screen. This enables you to check functions better. **Further information:** "Level display screen for TTL/HTL/HTLs", Page 93

i Information like, for example, the units for the count value display in **Angle [degrees]** or **Position [μm]** are read out and set automatically, depending on the encoder type.

8.4.7 More menu

You can open the **More** menu from the following screens of the Diagnosis menus by using the **More** button:

- **Online diagnostics** screen
- **Temperature** screen
- **Position** screen

The **More** menu provides the following screens:

Screen	Function
Display settings	The Display settings screen enables you to change the units of the values measured by the connected encoder. The setting options vary depending on the encoder. Further information: "Display settings screen ", Page 65
Datum shift	The Datum shift screen enables you to shift the datum of connected encoders. Further information: "Datum shift screen ", Page 66



- ▶ Tap **More**
- > The **More** menu is opened



The **More** menu changes with the **PWT display** screen and the **Level display** screen.

Further information: "More menu for TTL/HTL/HTLs", Page 103

Display settings screen

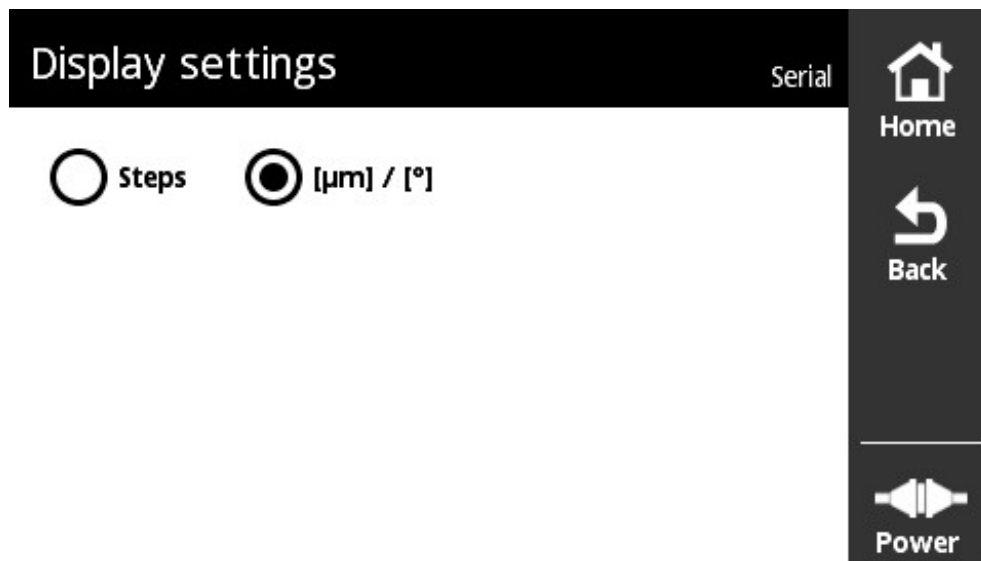

Figure 15: **Display settings** screen

The **Display settings** screen enables you to change the units of the values measured by the connected encoder. The setting options vary depending on the encoder.

Unit of measured position value

- Unit of encoder: μm or $^{\circ}$ (degrees)
- Steps [LSB] in the resolution of the connected encoder



i For individual encoders, for example strain sensors, the unit display is adapted, if necessary.

Changing the unit of the measured position values

You can choose between displaying measured position values in μm , $^{\circ}$ (degrees) or steps.

i Measured incremental position values can be displayed by the product only in **Steps**. You cannot change the unit of measured incremental position values.

i If you select $\mu\text{m} / ^{\circ}$, the product will display the measured values in μm or in $^{\circ}$ (degrees), depending on the encoder.

-  Tap **More**
 - > The **More** menu is opened
-  Tap **Units**
 - > The **Display settings** screen is opened
 - > Tap the desired unit
 - > The desired unit takes effect
-  Tap **Back**
 - > The changed settings take effect
 - > The **Display settings** screen is closed

Datum shift screen

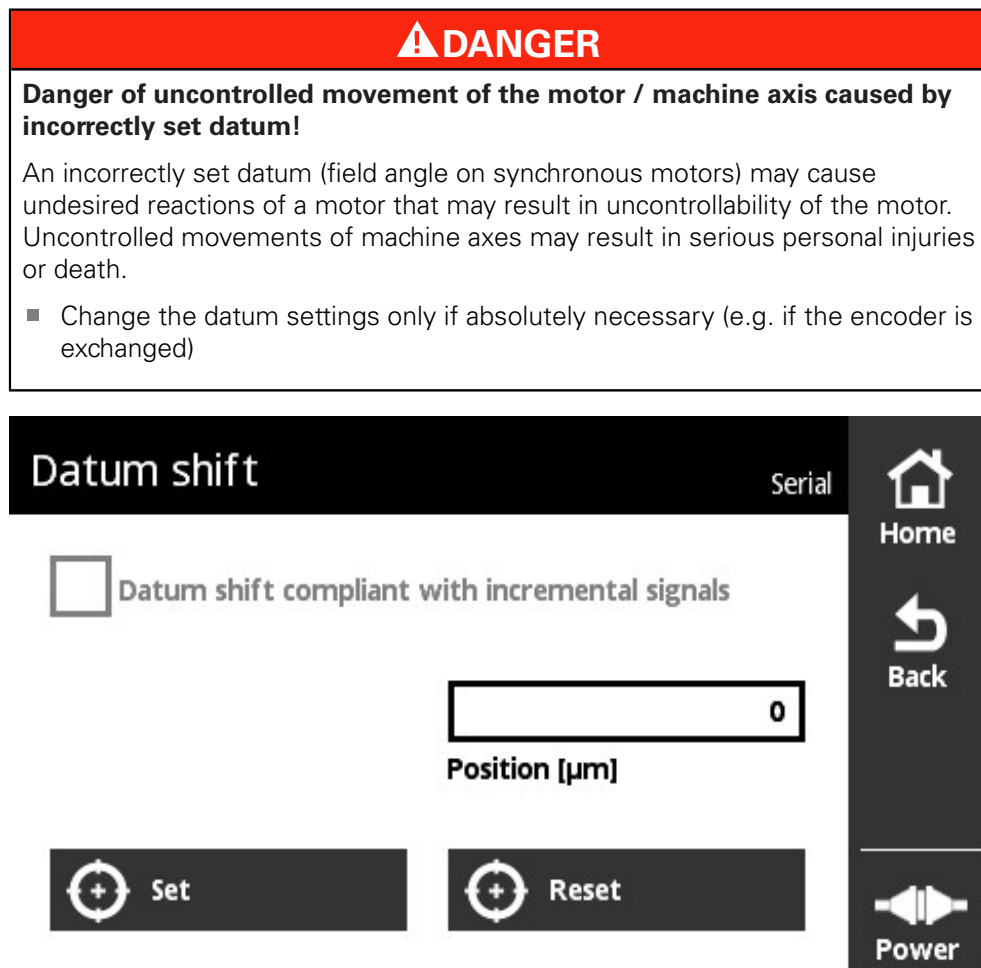

Figure 16: Datum shift screen

The **Datum shift** screen enables you to shift the datum of connected encoders.

i Not all encoders support a datum shift. If a connected encoder does not support a datum shift, the product displays a corresponding message.

Shifting the datum

A customer-specific datum shift can be performed for encoders with an EnDat interface, for example. The datum shift enables you to adapt the encoder to the machine and the motor for each individual axis (e.g. for measuring the rotor position on synchronous motors).

DANGER

Danger of uncontrolled movement of the motor / machine axis caused by incorrectly set datum!

An incorrectly set datum (field angle on synchronous motors) may cause undesired reactions of a motor that may result in uncontrollability of the motor. Uncontrolled movements of machine axes may result in serious personal injury or death.

- ▶ Do not change the datum settings
- ▶ Adjust the datum after exchanging the encoder
- ▶ For battery-buffered devices, observe the information provided by the machine manufacturer
- ▶ If you have any questions, contact the machine manufacturer or HEIDENHAIN
- ▶ Set the datum only while the encoder is at a standstill
- ▶ Before repeating a datum shift (e.g. for correction), you first need to cancel the current datum shift
- ▶ For encoder versions with incremental signals (ordering designations EnDat01 and EnDat02), select the **Datum shift compliant with incremental signals** checkbox in the **Datum shift** menu
- ▶ Observe the machine manufacturer's and the encoder manufacturer's documentation

WARNING

Danger of vertical or hanging machine axes!

If vertical or hanging machine axes are not secured, this may cause uncontrolled movement of these axes and may result in serious personal injury or death.

- ▶ Secure vertical or hanging axes against sagging



Changing the datum shift in the encoder can, for example, require a new acceptance test for functional-safety applications.



For linear encoders, set the datum shift so that no values < 0 are output for the position value.

Background:

EnDat does not support any negative position values. Instead of a negative sign, EnDat outputs the position value

"2ⁿNumber of clock pulses for transfer of the position value."



Certain applications may require commissioning the system after a datum shift has been performed.

Datum shift for multiturn rotary encoders

The following example applies to a multiturn rotary encoder and the setting [°] in the **More** menu.



- ▶ Tap **More**
- > The **More** menu is opened
- ▶ Tap **Datum Shift**
- > The **Datum shift** screen is opened
- ▶ Select or deselect the **Datum shift compliant with incremental signals** checkbox (where applicable)
- Further information:** "Assignment of zero position to signal period", Page 69
- ▶ Tap **Revolutions**
- > The product's virtual keyboard is opened
- ▶ Enter the value of the revolutions for the datum shift
- ▶ Tap **OK**
- ▶ Tap **Position within one revolution [degrees]**
- > The product's virtual keyboard is opened
- ▶ Enter the value of the position within one revolution for the datum shift
- ▶ Tap **OK**
- ▶ Tap the **Set** button
- > The datum is shifted
- > The message **Datum shift successful** appears
- ▶ Tap **OK**



If the datum shift was not successful, the product will display a corresponding message.

Resetting a datum shift

You can reset a datum shift you performed.



- ▶ Tap **More**
- > The **More** menu is opened
- ▶ Tap **Datum Shift**
- > The **Datum shift** screen is opened
- ▶ Tap the **Reset** button
- > The datum shift is reset
- > The message **Datum shift reset successful** appears
- ▶ Tap **OK**



If the datum shift was not successful, the product will display a corresponding message.

Assignment of zero position to signal period

The product checks the settings of the connected encoder and sets the **Datum shift compliant with incremental signals** checkbox by default to the recommended setting. You can change the recommended setting (where applicable).



The assignment of the zero position to the signal period (incremental signal) is taken into account.

The product calculates the new datum such that in relation to the incremental signals its position corresponds to the EnDat specification, i.e. is as close as possible to the desired position.



For EnDat01 and EnDat02 encoders, the assignment to the signal period must be taken into account.

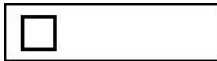

The assignment of the zero position to the signal period (incremental signal) is not taken into account.

Datum shifts that do not take the assignment of the zero position to the signal period (incremental signal) into account are used for purely serial encoders.



Purely serial encoders are encoders that do not output incremental signals. Interface designations for purely serial encoders are designations such as EnDat22 and EnDat21.

8.4.8 Encoder status screen

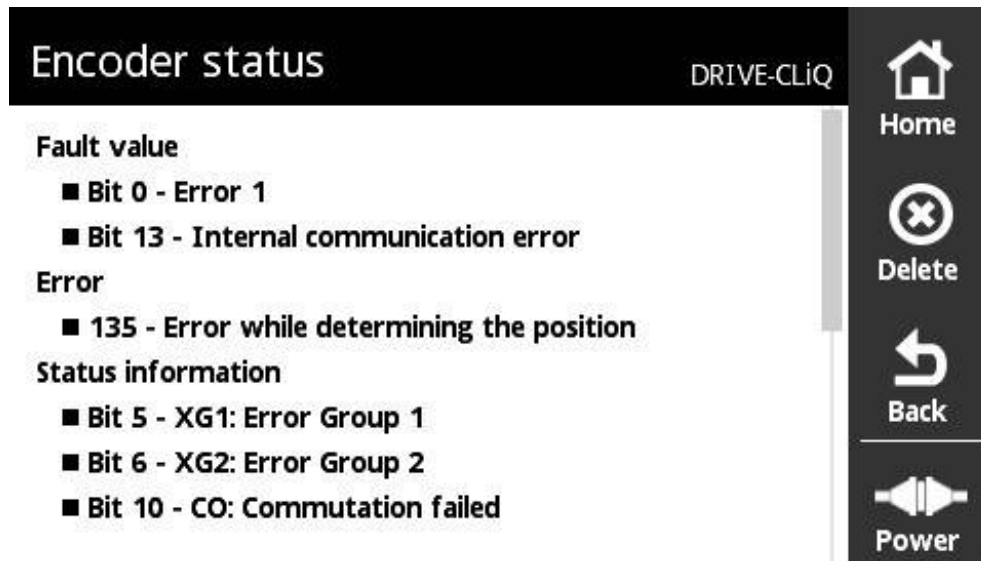

Figure 17: **Encoder status** (serial) screen

The **Encoder status** screen can be called from the following screens, using the **Status** button:

- **Online diagnostics** screen
- **Temperature** screen
- **Position** screen

The **Encoder status** screen displays messages and warnings informing the user about errors that occurred on the encoder and about the transmission status of the encoder.

If you use the serial interface to connect encoders to the product, each time position data is transmitted the product evaluates not only the position data but also the status information. This enables you to monitor connected encoders via the EnDat interface, for example.

The displayed messages vary depending on the encoder model and the encoder interface.

Classification of status messages

The messages displayed by the product for the serial interface are classified as follows:

Message	Description
Transmission errors	<p>Transmission errors indicate communication errors that may be caused by EMC influences, for example.</p> <p>Examples of transmission errors that may be displayed:</p> <ul style="list-style-type: none"> ■ Timeout ■ CRC error <p>Certain interfaces, such as EnDat, provide measures for protecting the transmission between the encoder and the subsequent electronics from transmission errors. Transmission can be protected by means of a CRC (cyclic redundancy check), for example.</p>
Encoder errors	<p>Encoder errors indicate a malfunction of the encoder.</p> <ul style="list-style-type: none"> ■ Examples of encoder errors that may be displayed by encoders with EnDat interface: <ul style="list-style-type: none"> ■ Bit 0 – Light source failure ■ Bit 1 – Signal amplitude faulty ■ Bit 2 – Position faulty ■ Bit 3 – Overvoltage ■ Bit 4 – Undervoltage supply ■ The Group alarm message is displayed by encoders with Fanuc, Mitsubishi, Yaskawa or Panasonic interface without any detailed information <p>If encoder errors are displayed, incorrect position values must be assumed. Operating condition error sources are displayed where appropriate. Operating condition error sources are extended encoder errors.</p>
Encoder warnings	<p>Encoder warnings indicate that certain tolerance limits of the encoder have been reached or exceeded.</p> <ul style="list-style-type: none"> ■ Examples of encoder warnings that may be displayed by encoders with EnDat interface: <ul style="list-style-type: none"> ■ Bit 1 – Temperature exceeded ■ The Group warning message is displayed by encoders with Fanuc, Mitsubishi, Yaskawa or Panasonic interface without any detailed information <p>The encoder warnings displayed do not state whether the measured position values are correct or incorrect.</p>

Clearing status messages



- ▶ Correct the error(s) displayed in the status message
- ▶ Tap **Delete**
- > Status messages about errors that have been corrected will be deleted
- > Status messages about errors that continue to exist will continue to be displayed
- ▶ If required, repeat this procedure until all pending status messages have been deleted



- ▶ Tap **Back**
- > The screen that was last selected is opened

8.5 Diagnostics for encoders with 1 V_{PP}/11 μA_{PP}/1 V_{PP} + Z1 interface

8.5.1 PWT display screen

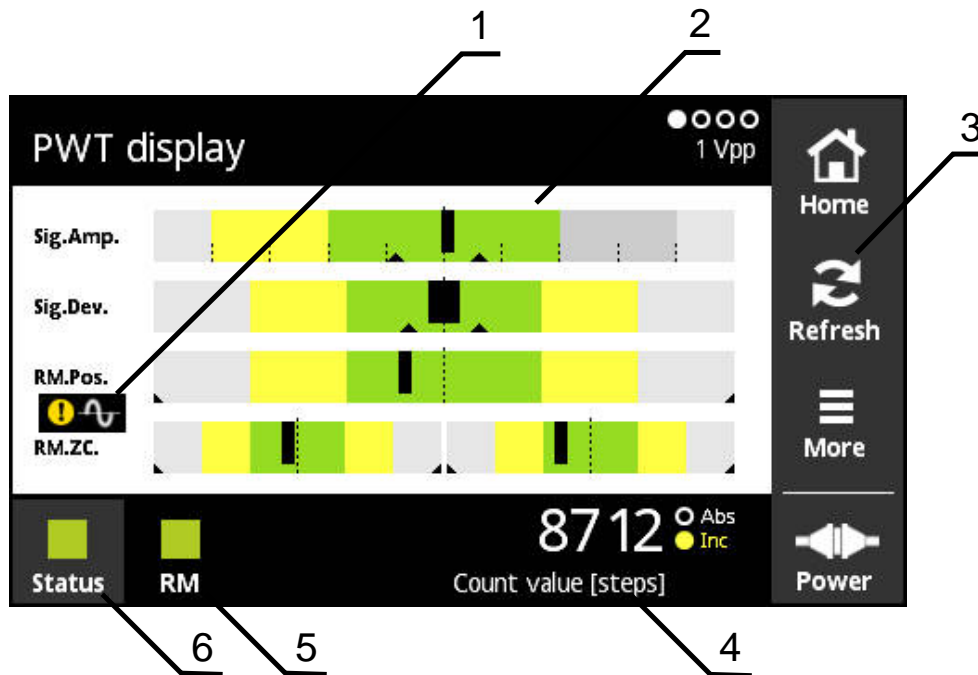

Figure 18: PWT display screen

- 1 Warning for signal evaluation
- 2 Bar graphs
- 3 Reset drag indicator or warning for signal evaluation
- 4 Count value
- 5 Reference mark status
- 6 Status

The **PWT display** screen uses bar graphs to evaluate incremental and reference mark signals of encoders with 1 V_{PP} or 11 μA_{PP} interface.

In order to obtain noise-free measurement results, additional signals, e.g. homing or limit signals, are deactivated if necessary.

Bar graphs for tolerance ranges

The **PWT display** screen uses bar graphs for depiction.

The following information about the encoders is shown:

- **Sig.Amp.** Signal amplitude
- **Sig.Dev.** Signal deviations
- **RM.Pos.** Reference mark position
- **RM.ZC.** Zero crossovers of reference-mark signal



The display for reference mark position or reference-mark zero crossovers is based on the definition in the "Interfaces of HEIDENHAIN Encoders" brochure. Since the definition may vary depending on the specific encoder, please refer to the documentation for the encoder or the manufacturer's documentation.

Display



Figure 19: Display of tolerance ranges

In the bar graphs the drag indicators (black triangles) indicate the minimum and maximum value, respectively. The product uses the following colors for displaying the tolerance ranges:

Color	Status	Description
Green	Pass	Values are within restricted tolerance range. Especially when an encoder is mounted (mounting situation), all display values should be within the green range.
Yellow	Adequate	Tolerance range is still within the specification. This means that the encoder functions properly.
Gray	Not sufficient	Values are outside the specifications. The encoder should no longer be operated. A detailed analysis of the encoder with a testing device (e.g. HEIDENHAIN PWM 21) is recommended.
<<	Outside of display	The values are far outside the tolerance range. A detailed analysis of the encoder with a testing device (e.g. HEIDENHAIN PWM 21) is recommended.



For more information, please refer to the Product Information or the Mounting Instructions for the encoder, or the "Interfaces of HEIDENHAIN Encoders" brochure.

Signal amplitude

In the bar graph of the signal amplitude, the position of the black bar indicates the incremental signal. The farther the black bar moves to the right, the larger the value of the signal amplitude is.

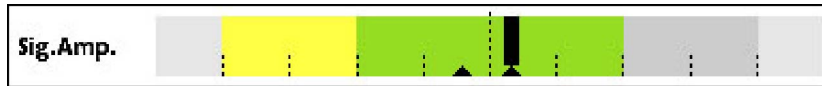

Figure 20: Signal amplitude 1 V_{pp} (distance between graduation lines: 0.1 V_{pp})

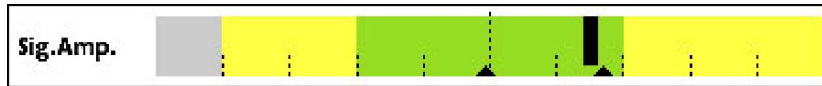

Figure 21: Signal amplitude 11 μA_{pp} (distance between graduation lines: 1 μA_{pp})

Depiction	Description
	Optimum signal amplitude
	Minimum signal amplitude
	Maximum signal amplitude

Signal amplitude in oscilloscope display

The graphic below shows an oscilloscope display of the signal amplitude. The oscilloscope display is not a function of the product and is intended only as an explanation.

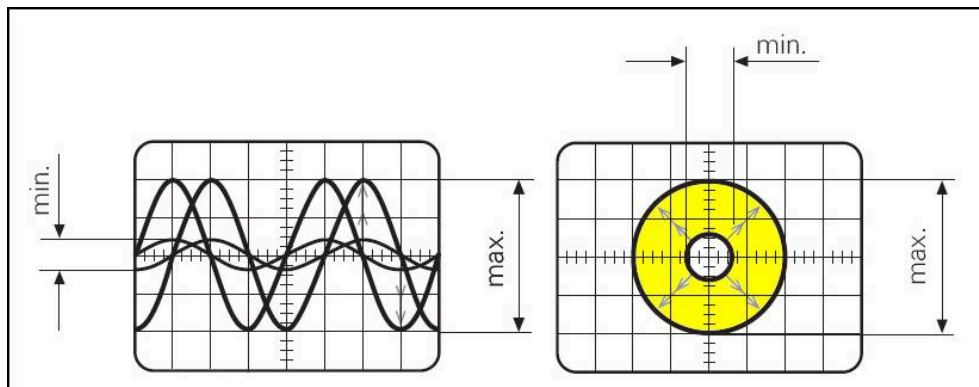

Figure 22: Oscilloscope display of signal amplitude

Signal deviations

Signal deviations are caused by asymmetry, signal ratio and phase angle. The larger the signal deviation is, the broader the black bar becomes. The signal deviation is optimal when the black bar is as narrow as possible within the green area. The signal deviation is too high if the black bar exceeds the yellow area.



Figure 23: Bar graph of signal deviation

Depiction	Description
	Optimum signal deviation
	Signal deviation at the tolerance limit
	Signal deviation too large

Signal deviation in oscilloscope display

The table below explains the signal amplitude in the oscilloscope displays. The oscilloscope display is not a function of the product and is intended only as an explanation.

Depiction	Description
	Optimum signal deviation
	Signal deviation at the tolerance limit
	Signal deviation too large

Reference mark position

The reference mark signal is at a specified nominal position. In the bar graph of the reference mark position, the position of the black bar indicates the deviation from the optimum position.



Figure 24: Bar graph of reference mark position

If certain limits are reached during the signal analysis of the encoder, for example an excessive signal frequency, the product cannot perform the signal analysis correctly. In this case, the drag indicators change and a warning symbol is shown. The drag indicators are set to the maximum values. After the next valid measurement, the values measured so far for the drag indicators are displayed.



After a certain time interval (15 s) the display is deactivated (gray). As soon as the device detects the next reference mark, the display is reactivated.

Zero crossovers of reference-mark signal

In the bar graph of the reference-mark zero crossovers, the positions of two black bars show the deviation of the zero crossovers of the reference mark signal from the specified values.

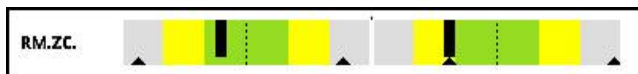

Figure 25: Bar graph of zero crossovers of reference-mark signal



After a certain time interval (15 s) the display is deactivated (gray). As soon as the device detects the next reference mark, the display is reactivated.

Resetting the drag indicators and warnings

You can reset the drag indicators and warnings displayed in the **PWT display** screen.



- ▶ Tap the **Refresh** button
- > The displayed drag indicators and warnings are reset

Diagnostic values of the PWT display

Count value

The **Count value [steps]** screen (4) shows count values, depending on the selection.

If, in the **Display settings** screen, the option **Rotatory** or **Linear** is selected, the count value display is set to **Abs**.

If, in the **Display settings** screen, the option **Steps** is selected, the count value display is set to **Inc**.

Count value	Yellow	White
Inc	Reference mark(s) not yet detected or Off selected	Reference mark(s) detected
Abs	Reference mark(s) not yet detected or Off selected	Reference mark(s) detected

Tapping the display opens the **Display options for count value** screen.

Further information: "Display options for count value screen ", Page 107

Reference mark

RM (5) shows the status of reference-mark detection. The product uses the following colors for displaying the status:

Color	Status	Description
Green	Reference mark detected	The display is activated for approx. 0.5 s. If the reference marks follow in too quick a succession, the display may seem to be continuously active.
Gray	Reference mark not detected	Reference mark not yet traversed or reference mark not detected

If the reference mark is not detected correctly during signal evaluation, a signal evaluation warning is additionally displayed next to the **RM.Pos.** (reference mark position) and **RM.ZC.** (reference-mark zero crossovers) bar graphs.

Status

The **Status** display (6) shows whether there are any messages about the connected encoder.

- Green: There are no messages
- Red: There are messages

Tapping the display opens the **Encoder status** screen.

Further information: "Encoder status screen ", Page 90

8.5.2 Sine commutation (1 V_{PP} + Z1) screen

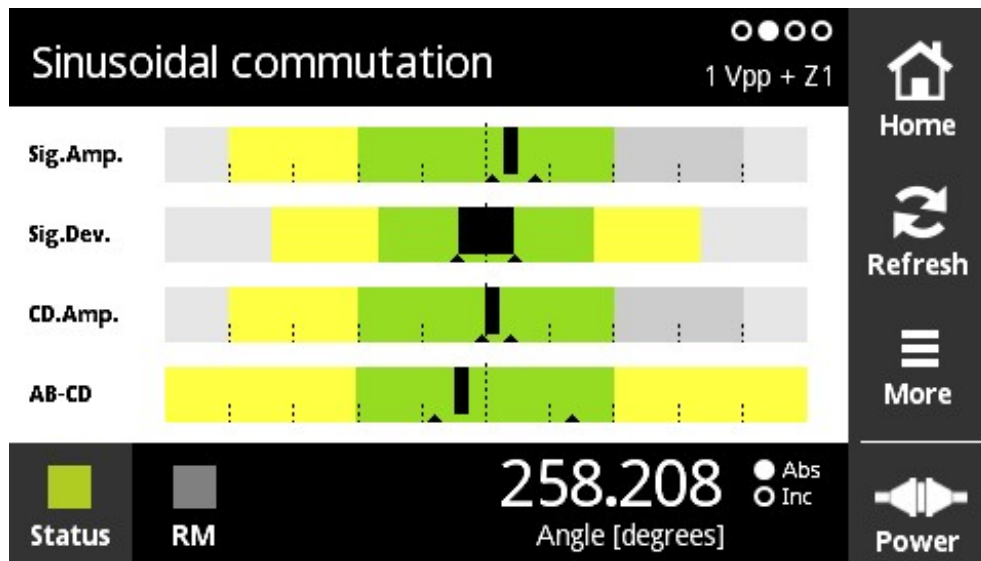

Figure 26: Sine commutation screen

The **Sine commutation** screen uses bar graphs to evaluate the commutation signal of encoders with 1 V_{PP} + Z1 interface.

The following information about the encoders is shown:

- **Sig.Amp.** Signal amplitude
- **Sig.Dev.** Signal deviation
- **CD.Amp.** Commutation signal CD
- **AB-CD** Deviation of AB and CD

The bar graphs for the display of the signal amplitude and signal deviation correspond to the bar graphs in the **PWT display** screen. **Further information:** "PWT display screen ", Page 73



The commutation signals C and D are taken from the so-called Z1 track, and are equal to one sine or cosine period per revolution. They have a signal amplitude of typically 1 V_{PP}.

Commutation signal CD

In the bar graph of the CD amplitude, the position of the black bar indicates the commutation signal. The farther the black bar moves to the right, the larger the value of the amplitude is.



Figure 27: CD amplitude 1 V_{PP} (distance between graduation lines: 0.1 V_{PP})

AB-CD deviation

In the bar graph of the AB-CD deviation, the position of the black bar indicates the deviation of the calculated Z1-track position. The reference to the corresponding reference position is made on the basis of the C and D signals. The reference position is established from the incremental track, based on the A and B signals. The farther the black bar moves away from the center position, the larger the deviation from the reference position is.



Figure 28: AB-CD deviation (distance between graduation lines: 1°, with one encoder revolution corresponding to 360°)

8.5.3 Encoder information screen

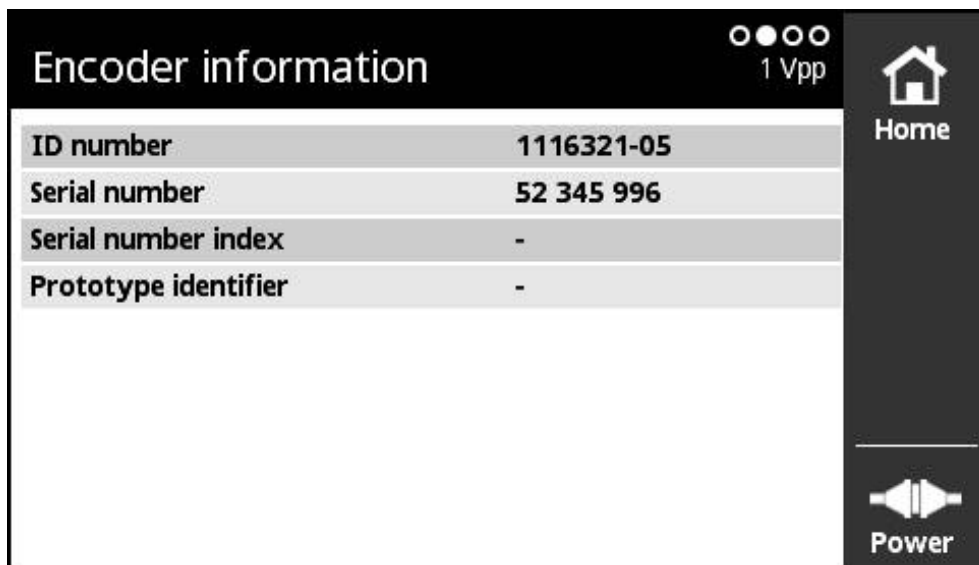

Figure 29: **Encoder information** screen

The **Encoder information** screen displays information saved about the connected encoder.

Precondition: The encoder supports this function.



The **Encoder information** screen displays only selected information on the connected encoder. This screen does not show the complete memory contents of the encoder.

8.5.4 Counts screen

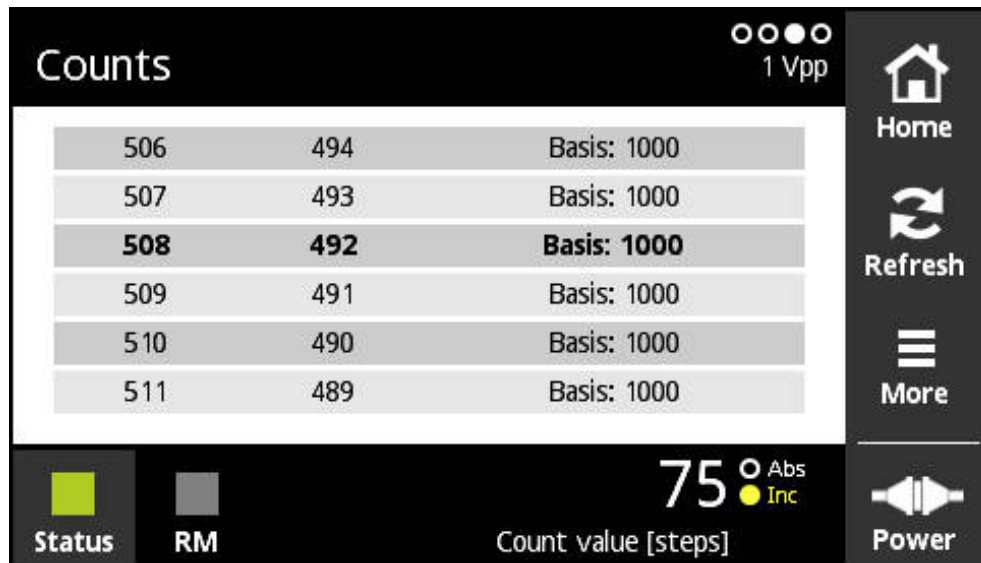
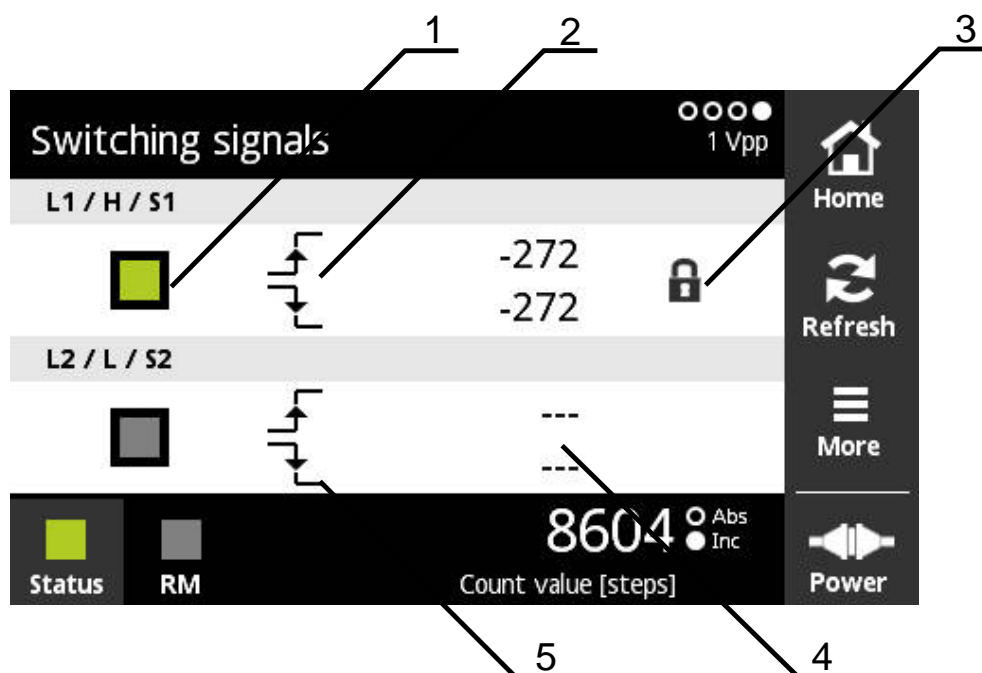

Figure 30: **Counts** screen

The **Counts** screen shows the distances of reference marks. The current value is displayed in bold. The list is adapted depending on the direction of rotation. With distance-coded reference marks, the nominal increment is shown in addition to the count values. For this purpose, the display is switched when the first count values have been ascertained and the count values and the nominal increment are shown in one line.

A deviation from the nominal value of the signal period between two reference marks or from the nominal increment indicates a malfunction or improper mounting of the encoder.

8.5.5 Switching signals screen

Figure 31: **Switching signals** screen

- 1 Signal level of the switching signal: gray (low) / green (high)
- 2 Rising edge
- 3 Locking function
- 4 No value determined
- 5 Falling edge

On the **Switching signals** screen, the proper functioning of switching signals, e.g. homing and limit signals, can be checked.



For information on the availability and function of the switching signals, please refer to the encoder documentation or the Interfaces of HEIDENHAIN Encoders brochure.

You can evaluate different switching signals. The possible settings for the different switching signals that can be evaluated are described in the **More** menu.

Further information: "Evaluation options for switching signals", Page 85



You have to home the encoder to ensure the proper functioning of the display. A corresponding note is displayed upon initial display or after a refresh.

Prior to referencing of encoders without distance-coded reference marks:



- ▶ In the **Display options for count value** screen, select the default value **Once**

Prior to referencing of encoders with distance-coded reference marks:

- ▶ In the **Display options for count value** screen, select the **c-Coded** value

Locking function

The **Switching signals** screen includes a locking function. The locking function enables you to lock or release count values. When you open the "Switching signals" screen for the first time, both padlock icons are shown opened. Updating of the count values is enabled. When two valid signal edges are detected, the padlock icon is closed automatically and the display is frozen. You can change the status by tapping the padlock icon. When you tap the padlock icon for the first time, the automatic operation of the locking function is stopped.

Status	Function
	<ul style="list-style-type: none"> ■ The display of the count values is frozen ■ The count values are no longer updated
	<ul style="list-style-type: none"> ■ Updating of the count values is enabled

8.5.6 More menu

You can open the **More** menu from the following screens of the Diagnosis menus by using the **More** button:

- **PWT display** screen
- **Sine commutation** (1 V_{PP} + Z1) screen
- **Counts** screen
- **Switching signals** screen

The **More** menu provides the following screens:

Screen	Function
Function settings	The Function settings screen enables you to switch on/off special encoder functions.
Display options for count value	The Display options for count value screen enables you to define display options for the count value.
Analysis information	The Analysis information screen shows messages on the signal analysis.
Display settings	In the Display settings screen, you can define and set the display of the count values.

 The functions provided by the **More** menu depend on the respective screens.

Opening the More menu



- ▶ Tap **More**
- > The **More** menu is opened



Function settings screen

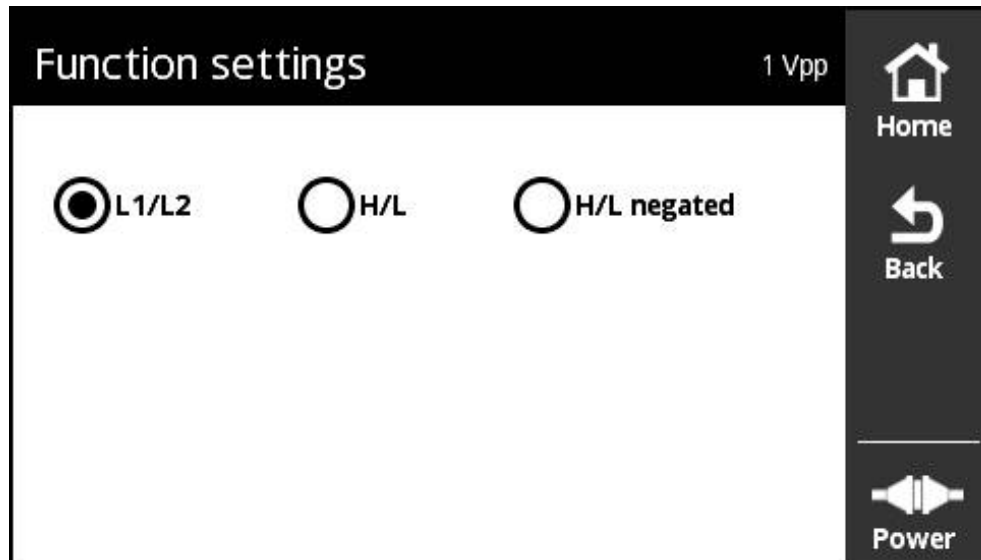

Figure 32: **Function settings** screen

The **Function settings** screen enables you to switch on/off special encoder functions.



The setting options vary depending on the encoder functions. The product adapts the displayed setting options correspondingly.

Deactivating the terminating resistor

You can activate or deactivate the terminating resistor on the product. The terminating resistor is activated in the default setting. The terminating resistor should be deactivated only in exceptional cases (for example, if two subsequent electronics are connected to an encoder).



- ▶ Tap **More**
- > The **More** menu is opened



- ▶ Tap **Functions**
- > The **Function settings** screen is opened
- ▶ Tap the **Terminating resistor is active** option
- > The terminating resistor is deactivated



- ▶ Tap **Back**
- > The changed settings take effect
- > The **Function settings** screen is closed

Deactivating the HSP function

Certain encoders from HEIDENHAIN provide the HSP function that can be activated or deactivated. The HSP function is activated in the default setting.

The HSP function should be deactivated only when the encoder is mounted. A corresponding message will then be shown in the **PWT display** screen.

When an encoder is tested after it has been mounted, the HSP function should be activated. This default setting is activated when the **PWT display** screen is closed.



For encoders with TTL interface, the HSP function is automatically set by the encoder when PWT switchover is activated.



Refer to the mounting instructions for the specific encoder.



- ▶ Tap **More**
- > The **More** menu is opened



- ▶ Tap **Functions**
- > The **Display settings** screen is opened
- ▶ Tap the **Evaluation of incremental signals (HSP active)** option
- > The HSP function is deactivated



- ▶ Tap **Back**
- > The changed settings take effect
- > The **Display settings** screen is closed

Evaluation options for switching signals

Selection	Function
L1/L2	The rising and falling edges are evaluated for the L2/L/S2 switching signals. Select this setting if the encoder provides the L1 or L2 switching signals on separate signal pins.
H/L (Setting for encoder standard versions)	Two rising edges are evaluated for the L2/L/S2 switching signals. This is indicated by the corresponding numbering after the edge symbol. Select this setting if the encoder supports the Limit and Homing switching signals.
H/L negated (Setting for special versions of encoders)	Two falling edges are evaluated for the L2/L/S2 switching signals. This is indicated by the corresponding numbering after the edge symbol. Select this setting if the encoder supports the Limit and Homing switching signals.

Setting evaluation options for switching signals



- ▶ Tap **More**
- > The **More** menu is opened



- ▶ Tap **Functions**
- > The **Function settings** screen is opened
- ▶ Tap the desired mode of evaluation of the switching signals
- > The switching signal evaluation was successfully selected



- ▶ Tap **Back**
- > The changed settings take effect
- > The **Function settings** screen is closed

Display options for count value screen

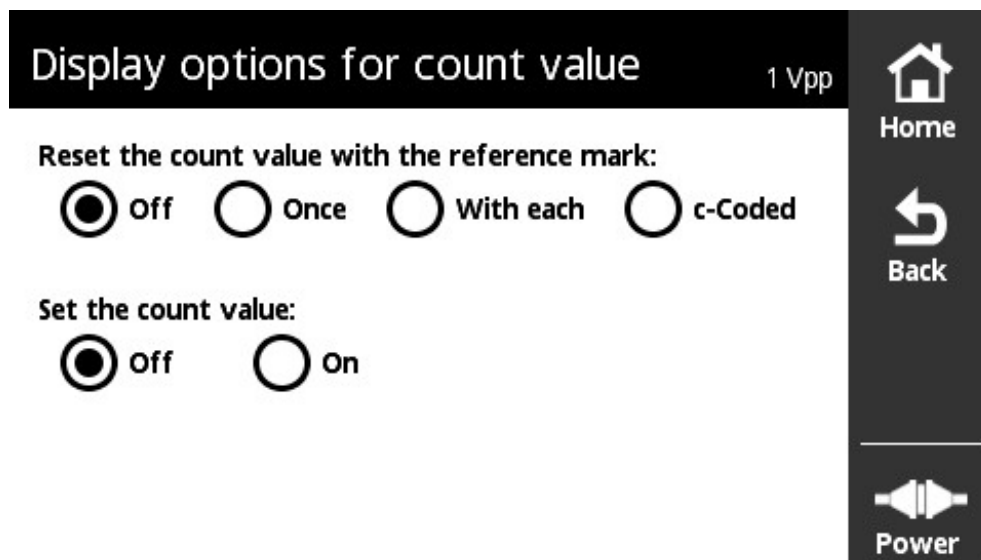

Figure 33: **Display options for count value** screen

The **Display options for count value** screen enables you to define display options for the count value.



The setting options vary depending on the encoder functions. The product adapts the displayed setting options correspondingly.

Resetting the count value

The count value counts the signal periods of the incremental signals of the connected encoder. The count value is always an incremental value.

The **Reset the count value with the reference mark:** parameter provides the following options:

Selection	Description
Off	The count value counts the signal periods without any other starting conditions. If this option is selected, you can set the Set the count value: parameter to On and enter a starting value in the Count value [steps] field. After tapping Back, the count value is set to the starting value entered and the product starts counting.
Once	The count value is set to "0" and counting starts with the detection of the reference mark. When the count value is detected, the parameter is set to Off again.
With each	The count value is set to "0" and counting starts with the detection of the reference mark. When the next reference mark is detected, the count value display freezes for approx. 0.5 s. This enables you to check the number of signal periods between reference marks for distance-coded encoders, for example.
c-Coded	The count value is set to "0" and is then changed to the corresponding count value after the coding of the reference marks has been detected. When the count value is detected, the parameter is set to Off again.

Defining the count values

The **Set the count value:** parameter contains the starting value from which the product starts counting. The following instruction describes the entry of the count value:



- ▶ Tap **More**
- > The **More** menu is opened
- ▶ Tap **Counter**
- > The **Display options for count value** screen is opened
- ▶ Tap the **Off** option of the **Reset the count value with the reference mark:** parameter
- ▶ Tap the **On** option of the **Set the count value:** parameter
- > **Count value [steps]** is displayed
- ▶ Tap **Count value [steps]**
- > The product's on-screen keyboard is opened
- ▶ Enter the desired starting value
- ▶ Tap **OK**
- ▶ Tap **Back**
- > The changed settings take effect
- > The **Display options for count value** screen is closed

Analysis information screen

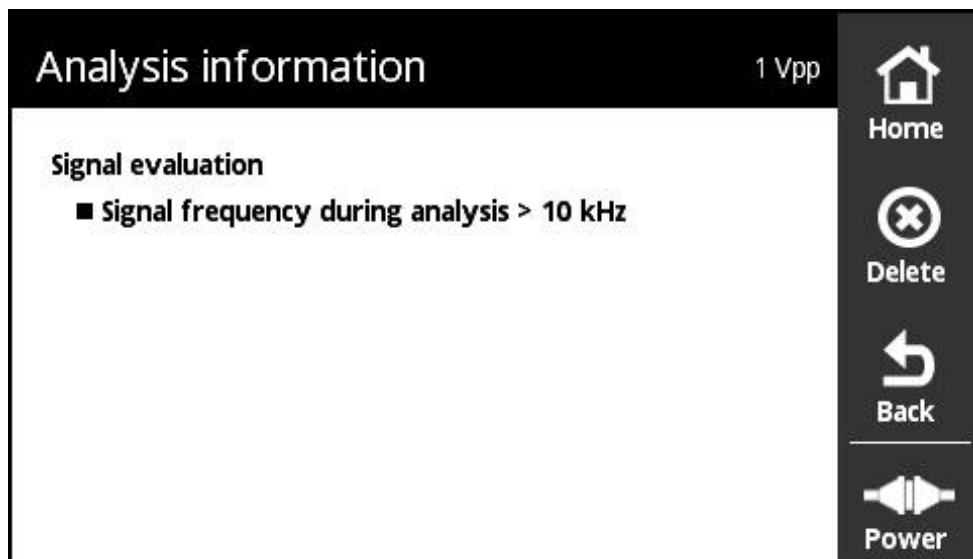



Figure 34: **Analysis information** screen

The **Analysis information** screen shows messages on the signal analysis.



The messages depend on the encoder functions. You can reset the messages.

Classification of signal messages

Message	Category	Description
Frequency exceeded	Signal evaluation	Signal frequency too high, the testing tolerances can no longer be guaranteed
Reference mark not correctly detected	Signal evaluation	The reference mark was not correctly detected

Opening Analysis information



- ▶ Tap **More**
- > The **More** menu is opened



- ▶ Tap **Analysis**
- > The **Analysis information** screen is opened

Clearing status messages



Delete

- ▶ Correct the error(s) displayed in the status message
- ▶ Tap **Delete**
- Status messages about errors that have been corrected will be deleted
- Status messages about errors that continue to exist will continue to be displayed
- ▶ If required, repeat this procedure until all pending status messages have been deleted



Back

- ▶ Tap **Back**
- The screen that was last selected is opened

Display settings screen

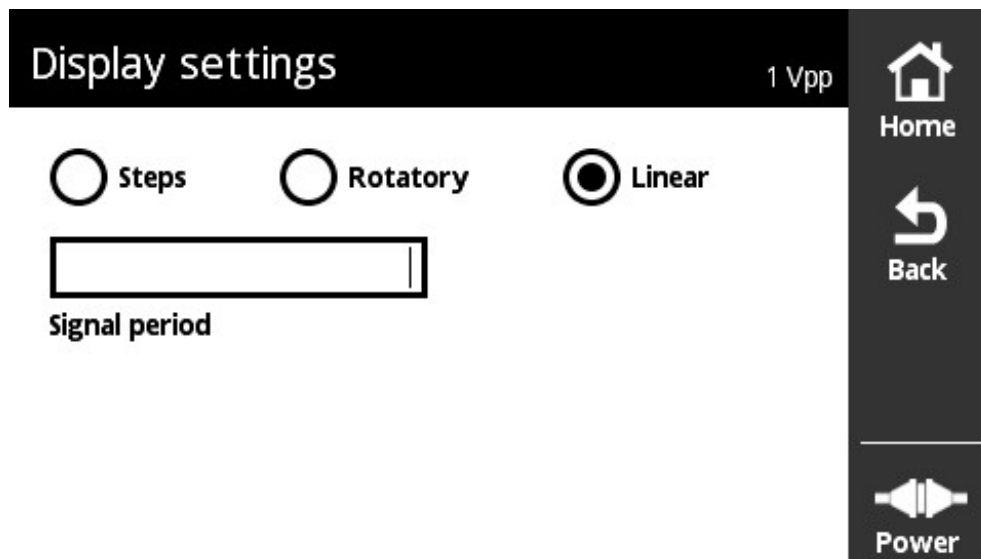

Figure 35: **Display settings** screen

The **Display settings** screen enables you to change the units of the measured values of the encoder. The setting has an effect on the count values displayed.

Selection	Description
Steps	Incremental display of counting values. Indicated in signal periods.
Rotatory	The count values are displayed as Angle [degrees] . You have to enter the encoder's line count.
Linear	The count values are displayed as Position [μm] . You have to enter the signal period of the encoder.



The choice of the count value unit affects all screens.

Opening Display settings



More

- ▶ Tap **More**
- The **More** menu is opened



Units

- ▶ Tap **Units**
- The **Display settings** screen is opened

8.5.7 Encoder status screen

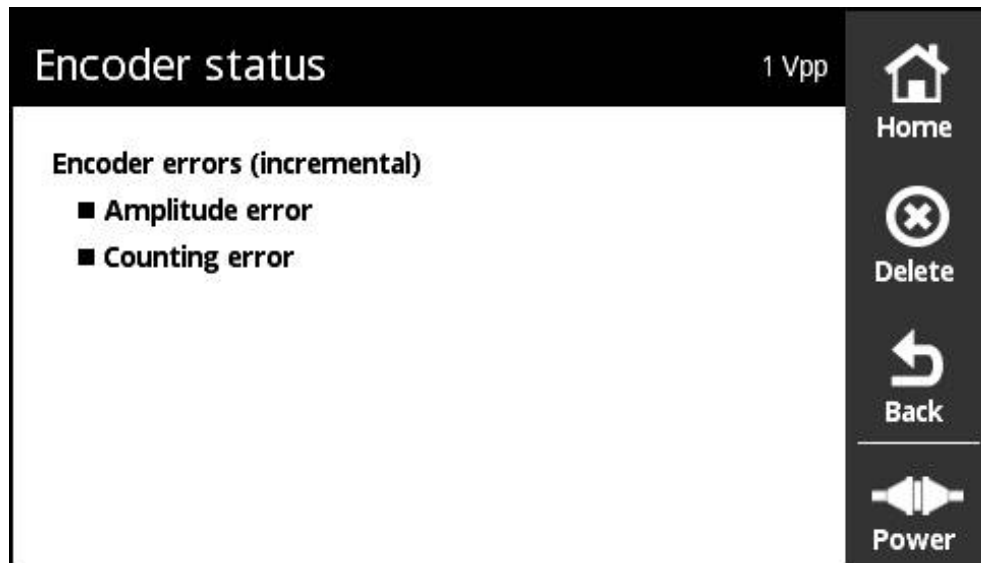

Figure 36: **Encoder status** screen (1 V_{PP}/11 μA_{PP})

The **Encoder status** screen displays encoder errors.

The **Encoder status** screen can be called from the following screens, using the **Status** button.

- **PWT display** screen
- **Counts** screen
- **Switching signals** screen

Classification of encoder errors

The messages displayed by the product for the 1 V_{PP} and 11 μA_{PP} interface are classified as follows:

Status screen	Message	Description
Red	Amplitude error	Signal amplitude is too small (< 0.3 V _{PP} or 3 μA _{PP}) or too large (> 1.35 V _{PP} or 18 μA _{PP})
Red	Counting error	A counting error occurred (counting order Ua1, Ua2 is incorrect or the counting interval is too small)
Red	Invalid numerical value between two reference marks	An incorrect count value was detected while checking the position during reference-mark crossover. Example: When using a rotational encoder with a reference mark, a distance of 0 or the line count must always be detected between two reference marks.
Red	Reference mark not found	A reference mark that was expected due to the current position value could not be identified. Example: When using a rotational encoder with a reference mark, a reference mark must always be detected at position 0 after referencing.

Clearing status messages



- ▶ Correct the error(s) displayed in the status message
- ▶ Tap **Delete**
- > Status messages about errors that have been corrected will be deleted
- > Status messages about errors that continue to exist will continue to be displayed
- ▶ If required, repeat this procedure until all pending status messages have been deleted



- ▶ Tap **Back**
- > The screen that was last selected is opened

8.6 Diagnosis for encoders with TTL/HTL/HTLs/ interface



Use the adapter 1093210-01 to connect encoders with HTL, HTLs or Serial + HTL interfaces to the PWT.

The diagnosis for encoders with HTL, HTLs or Serial + HTL interfaces can only be started via the **Manual Diagnosis**.

Further information: "Performing Manual Diagnosis", Page 56

8.6.1 Level display screen for TTL/HTL/HTLs

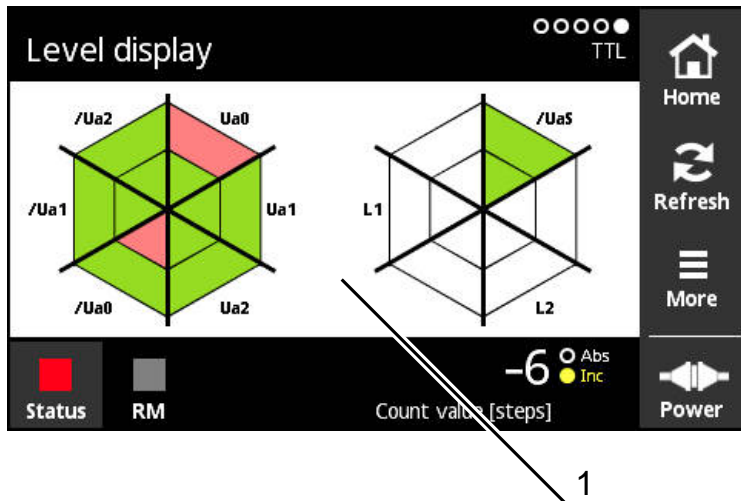

Figure 37: **Level display** screen

1 Warning for signal evaluation

The **Level display** screen shows the levels of the individual signals of encoders with TTL and HTL interface.

The graphic shows the possible number of signals that can be tested. The inner area shows the evaluation of the low level, and the outer area the evaluation of the high level. If signals are missing, the respective area of the graphic remains white.

The product uses the following colors to display the signals:

Color	Status	Description
Green	Adequate	The signal is within the specified range
Red	Not sufficient	The signal is outside the specified range
White	No value	The signal has not yet been evaluated or the signal is not available



Depending on the respective signal, the level of each individual signal and the difference in levels are checked.

The following monitoring limits apply (shown as approximate values without indication of tolerance):

TTL

- Single level: < 0.6 V and 2.2 V
- Difference in levels: > 0.85 V

HTL

- Single level: < 2.0 V and > 4.4 V
- Difference in levels: > 1.7 V

8.6.2 Encoder information screen for TTL/HTL/HTLs

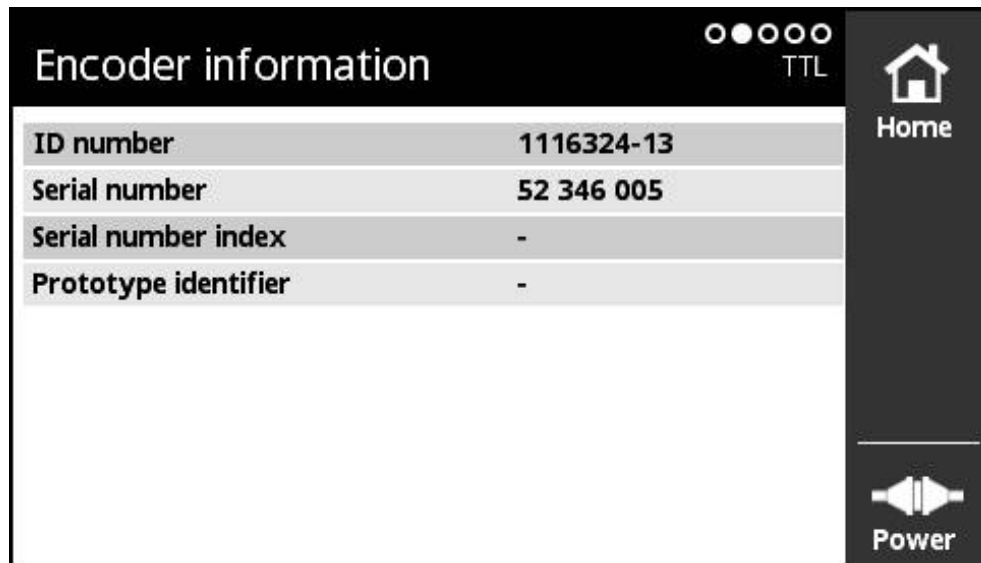

Figure 38: **Encoder information** screen

The **Encoder information** screen displays information saved about the connected encoder.

Precondition: The encoder supports this function.



The **Encoder information** screen displays only selected information on the connected encoder. This screen does not show the complete memory contents of the encoder.

8.6.3 Counts screen for TTL/HTL/HTLs

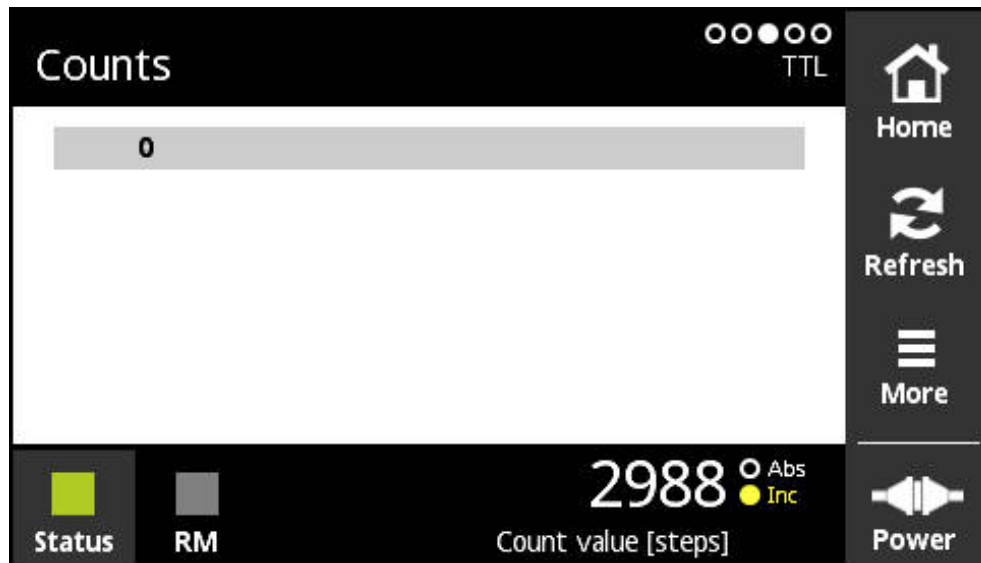

Figure 39: **Counts** screen

The **Counts** screen shows the distances of reference marks. The current value is displayed in bold. The list is adapted depending on the direction of rotation. With distance-coded reference marks, the nominal increment is shown in addition to the count values. For this purpose, the display is switched when the first count values have been ascertained and the count values and the nominal increment are shown in one line.

A deviation from the nominal value of the signal period between two reference marks or from the nominal increment indicates a malfunction or improper mounting of the encoder.

8.6.4 Switching signals screen for TTL

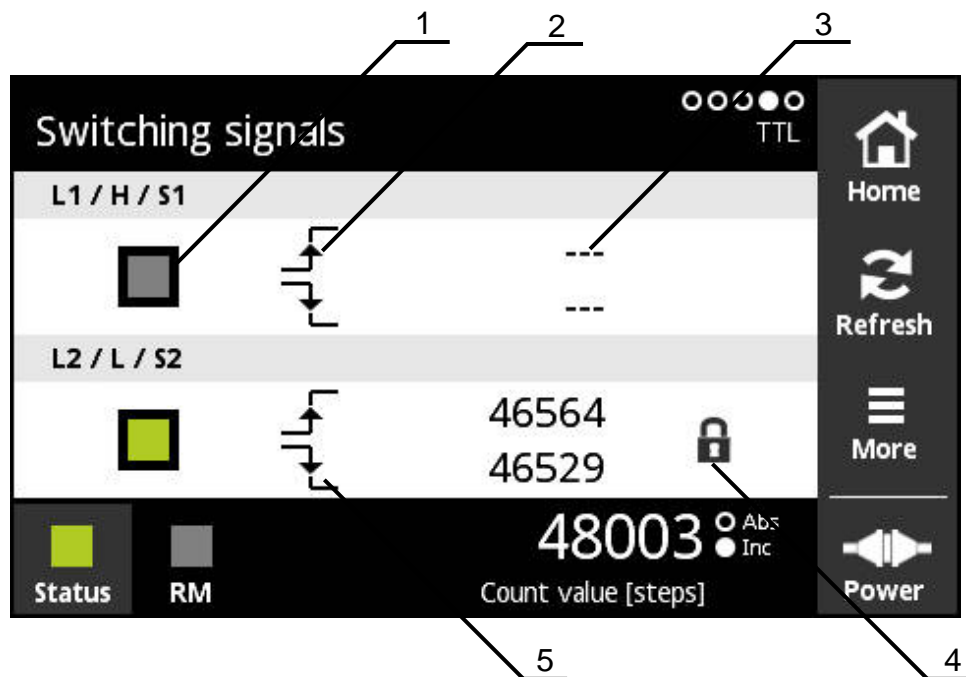

Figure 40: **Switching signals** screen

- 1 Signal level of the switching signal: gray (low) / green (high)
- 2 Rising edge
- 3 No value determined
- 4 Locking function
- 5 Falling edge

On the **Switching signals** screen, the proper functioning of switching signals, e.g. homing and limit signals, can be checked. For information on the availability and function of the switching signals, please refer to the encoder documentation or the Interfaces of HEIDENHAIN Encoders brochure.

You can evaluate different **Switching signals**. The available options are shown in the **More** menu.



Further information: "Function settings screen ", Page 104



The encoder must be homed to ensure the proper functioning of the display. A corresponding note is shown upon initial display or after a refresh.

Locking function

The **Switching signals** screen includes a locking function. The locking function enables you to lock or release count values. When you open the "Switching signals" screen for the first time, both padlock icons are shown opened. Updating of the count values is enabled. When two valid signal edges are detected, the padlock icon is closed automatically and the display is frozen. You can change the status by tapping the padlock icon. When you tap the padlock icon for the first time, the automatic operation of the locking function is stopped.

Status	Function
	<ul style="list-style-type: none"> The display of the count values is frozen The count values are no longer updated
	<ul style="list-style-type: none"> Updating of the count values is enabled

8.6.5 PWT display screen for TTL

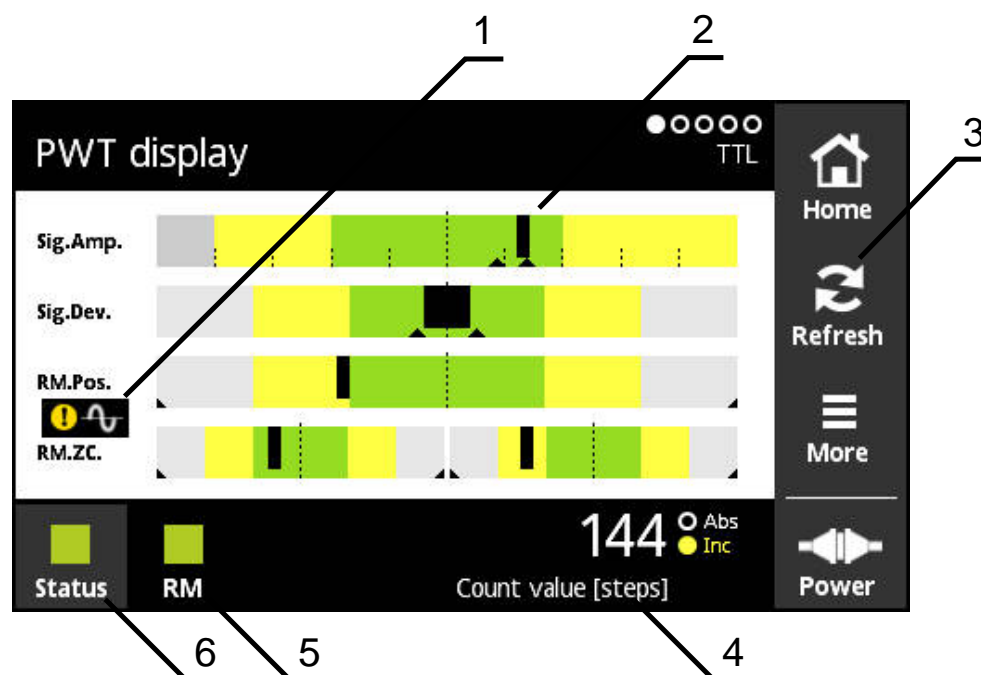

Figure 41: PWT display screen

- 1 Warning for signal evaluation
- 2 Bar graphs
- 3 Reset drag indicator or warning for signal evaluation
- 4 Count value
- 5 Reference mark status
- 6 Status

The **PWT display** screen uses bar graphs to evaluate incremental and reference mark signals of encoders with TTL interface that feature a PWT switchover function.

In order to obtain noise-free measurement results, additional signals, e.g. homing or limit signals, are deactivated if necessary.

Bar graphs for tolerance ranges

The **PWT display** screen uses bar graphs for depiction.

The following information about the encoders is shown:

- **Sig.Amp.** Signal amplitude
- **Sig.Dev.** Signal deviations
- **RM.Pos.** Reference mark position
- **RM.ZC.** Zero crossovers of reference-mark signal



The display for reference mark position or reference-mark zero crossovers is based on the definition in the "Interfaces of HEIDENHAIN Encoders" brochure. Since the definition may vary depending on the specific encoder, please refer to the documentation for the encoder or the manufacturer's documentation.

Display



Figure 42: Display of tolerance ranges

In the bar graphs the drag indicators (black triangles) indicate the minimum and maximum value, respectively. The product uses the following colors for displaying the tolerance ranges:

Color	Status	Description
Green	Pass	Values are within restricted tolerance range. Especially when an encoder is mounted (mounting situation), all display values should be within the green range.
Yellow	Adequate	Tolerance range is still within the specification. This means that the encoder functions properly.
Gray	Not sufficient	Values are outside the specifications. The encoder should no longer be operated. A detailed analysis of the encoder with a testing device (e.g. HEIDENHAIN PWM 21) is recommended.
<<	Outside of display	The values are far outside the tolerance range. A detailed analysis of the encoder with a testing device (e.g. HEIDENHAIN PWM 21) is recommended.



For more information, please refer to the Product Information or the Mounting Instructions for the encoder, or the "Interfaces of HEIDENHAIN Encoders" brochure.

Signal amplitude

In the bar graph of the signal amplitude, the position of the black bar indicates the incremental signal. The farther the black bar moves to the right, the larger the value of the signal amplitude is.

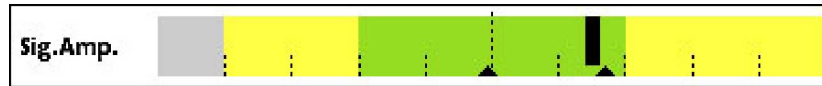





Figure 43: Signal amplitude TTL (distance between graduation lines: 1 μ App)

Depiction	Description
	Optimum signal amplitude
	Minimum signal amplitude
	Maximum signal amplitude

Signal amplitude in oscilloscope display

The graphic below shows an oscilloscope display of the signal amplitude. The oscilloscope display is not a function of the product and is intended only as an explanation.

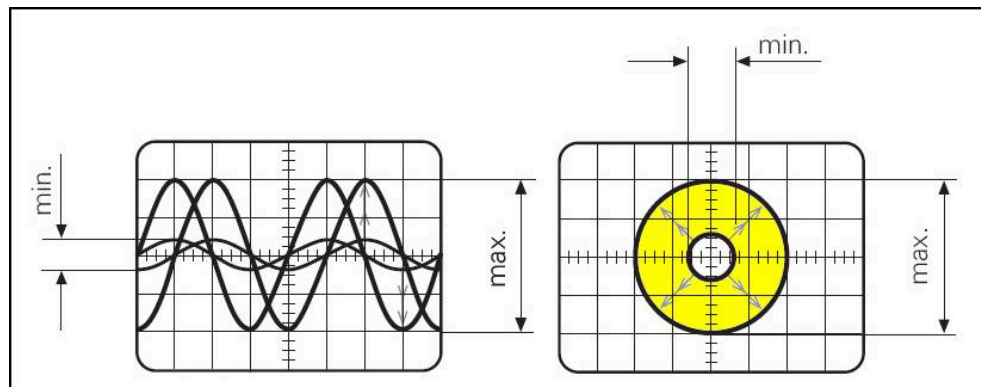





Figure 44: Oscilloscope display of signal amplitude

Signal deviations

Signal deviations are caused by asymmetry, signal ratio and phase angle. The larger the signal deviation is, the broader the black bar becomes. The signal deviation is optimal when the black bar is as narrow as possible within the green area. The signal deviation is too high if the black bar exceeds the yellow area.

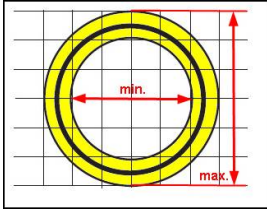
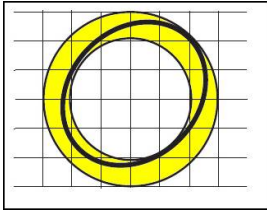
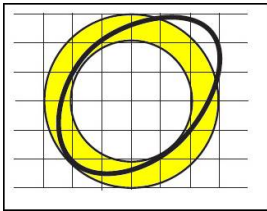

Figure 45: Bar graph of signal deviation

Depiction	Description
	Optimum signal deviation
	Signal deviation at the tolerance limit
	Signal deviation too large

Signal deviation in oscilloscope display

The table below explains the signal amplitude in the oscilloscope displays. The oscilloscope display is not a function of the product and is intended only as an explanation.

Depiction	Description
	Optimum signal deviation
	Signal deviation at the tolerance limit
	Signal deviation too large

Reference mark position

The reference mark signal is at a specified nominal position. In the bar graph of the reference mark position, the position of the black bar indicates the deviation from the optimum position.



Figure 46: Bar graph of reference mark position

If certain limits are reached during the signal analysis of the encoder, for example an excessive signal frequency, the product cannot perform the signal analysis correctly. In this case, the drag indicators change and a warning symbol is shown. The drag indicators are set to the maximum values. After the next valid measurement, the values measured so far for the drag indicators are displayed.



After a certain time interval (15 s) the display is deactivated (gray). As soon as the device detects the next reference mark, the display is reactivated.

Zero crossovers of reference-mark signal

In the bar graph of the reference-mark zero crossovers, the positions of two black bars show the deviation of the zero crossovers of the reference mark signal from the specified values.



Figure 47: Bar graph of zero crossovers of reference-mark signal



After a certain time interval (15 s) the display is deactivated (gray). As soon as the device detects the next reference mark, the display is reactivated.

Resetting the drag indicators and warnings

You can reset the drag indicators and warnings displayed in the **PWT display** screen.



- ▶ Tap the **Refresh** button
- > The displayed drag indicators and warnings are reset

Diagnostic values of the PWT display

Count value

The **Count value [steps]** screen (4) shows count values, depending on the selection.

If, in the **Display settings** screen, the option **Rotatory** or **Linear** is selected, the count value display is set to **Abs**.

If, in the **Display settings** screen, the option **Steps** is selected, the count value display is set to **Inc**.

Count value	Yellow	White
Inc	Reference mark(s) not yet detected or Off selected	Reference mark(s) detected
Abs	Reference mark(s) not yet detected or Off selected	Reference mark(s) detected

Tapping the display opens the **Display options for count value** screen.

Further information: "Display options for count value screen ", Page 107

Reference mark

RM (5) shows the status of reference-mark detection. The product uses the following colors for displaying the status:

Color	Status	Description
Green	Reference mark detected	The display is activated for approx. 0.5 s. If the reference marks follow in too quick a succession, the display may seem to be continuously active.
Gray	Reference mark not detected	Reference mark not yet traversed or reference mark not detected

If the reference mark is not detected correctly during signal evaluation, a signal evaluation warning is additionally displayed next to the **RM.Pos.** (reference mark position) and **RM.ZC.** (reference-mark zero crossovers) bar graphs.

Status

The **Status** display (6) shows whether there are any messages about the connected encoder.

- Green: There are no messages
- Red: There are messages

Tapping the display opens the **Encoder status** screen.

Further information: "Encoder status screen ", Page 90

8.6.6 More menu for TTL/HTL/HTLs

You can open the **More** menu from the following screens of the Diagnosis menus by using the **More** button:

- **Level display** screen
- **Counts** screen
- **Switching signals** screen
- **PWT display** screen

The **More** menu provides the following screens:

Screen	Function
Function settings	The Function settings screen enables you to switch on/off special encoder functions.
Display options for count value	The Display options for count value screen enables you to define display options for the count value.
Analysis information	The Analysis information screen shows messages on the signal analysis.
Display settings	In the Display settings screen, you can define and set the display of the count values.

Opening the More menu



- ▶ Tap **More**
- > The **More** menu is opened



Function settings screen

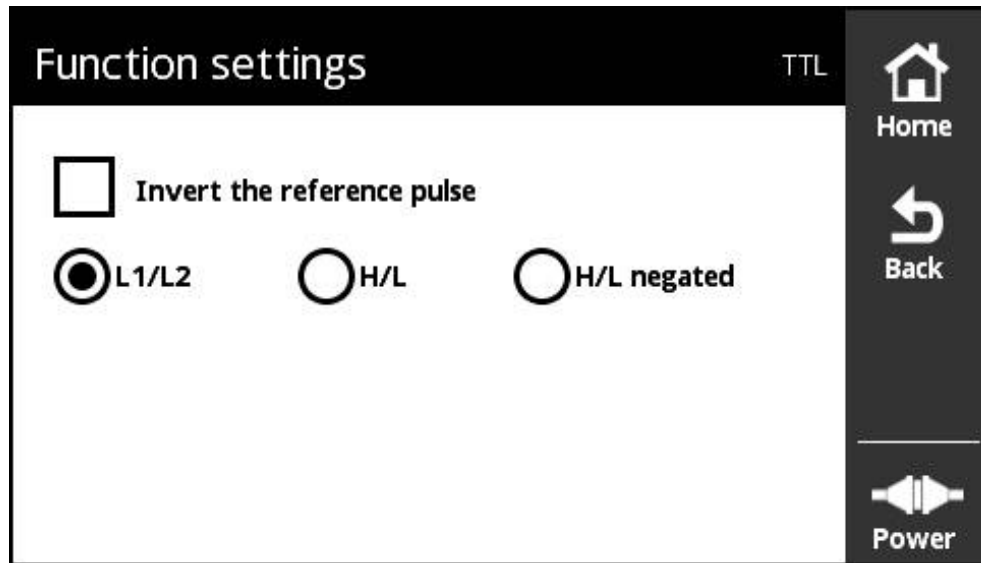

Figure 48: **Function settings** screen (TTL)

The **Function settings** screen enables you to switch on/off special encoder functions.



The setting options vary depending on the encoder functions.
The product adapts the displayed setting options correspondingly.

Deactivating the terminating resistor

You can activate or deactivate the terminating resistor on the product. The terminating resistor is activated in the default setting. The terminating resistor should be deactivated only in exceptional cases (for example, if two subsequent electronics are connected to an encoder).



More

- ▶ Tap **More**
- > The **More** menu is opened



Functions

- ▶ Tap **Functions**
- > The **Function settings** screen is opened
- ▶ Tap the **Terminating resistor is active** option
- > The terminating resistor is deactivated



Back

- ▶ Tap **Back**
- > The changed settings take effect
- > The **Function settings** screen is closed

Deactivating the HSP function

Certain encoders from HEIDENHAIN provide the HSP function that can be activated or deactivated. The HSP function is activated in the default setting.

The HSP function should be deactivated only when the encoder is mounted. A corresponding message will then be shown in the **PWT display** screen.

When an encoder is tested after it has been mounted, the HSP function should be activated. This default setting is activated when the **PWT display** screen is closed.



For encoders with TTL interface, the HSP function is automatically set by the encoder when PWT switchover is activated.



Refer to the mounting instructions for the specific encoder.



- ▶ Tap **More**
- > The **More** menu is opened



- ▶ Tap **Functions**
- > The **Display settings** screen is opened
- ▶ Tap the **Evaluation of incremental signals (HSP active)** option
- > The HSP function is deactivated



- ▶ Tap **Back**
- > The changed settings take effect
- > The **Display settings** screen is closed

Inverting the reference pulse

You can invert the evaluation of the encoder's reference pulse on the product.



- ▶ Tap **More**
- > The **More** menu is opened



- ▶ Tap **Functions**
- > The **Function settings** screen is opened
- ▶ Tap the **Invert the reference pulse** option
- > The evaluation of the reference pulse is inverted.



- ▶ Tap **Back**
- > The changed settings take effect
- > The **Function settings** screen is closed

Evaluation options for switching signals

Selection	Function
L1/L2	The rising and falling edges are evaluated for the L2/L/S2 switching signals. Select this setting if the encoder provides the L1 or L2 switching signals on separate signal pins.
H/L (Setting for encoder standard versions)	Two rising edges are evaluated for the L2/L/S2 switching signals. This is indicated by the corresponding numbering after the edge symbol. Select this setting if the encoder supports the Limit and Homing switching signals.
H/L negated (Setting for special versions of encoders)	Two falling edges are evaluated for the L2/L/S2 switching signals. This is indicated by the corresponding numbering after the edge symbol. Select this setting if the encoder supports the Limit and Homing switching signals.

Setting evaluation options for switching signals



- ▶ Tap **More**
- > The **More** menu is opened



- ▶ Tap **Functions**
- > The **Function settings** screen is opened
- ▶ Tap the desired mode of evaluation of the switching signals
- > The switching signal evaluation was successfully selected



- ▶ Tap **Back**
- > The changed settings take effect
- > The **Function settings** screen is closed

Display options for count value screen

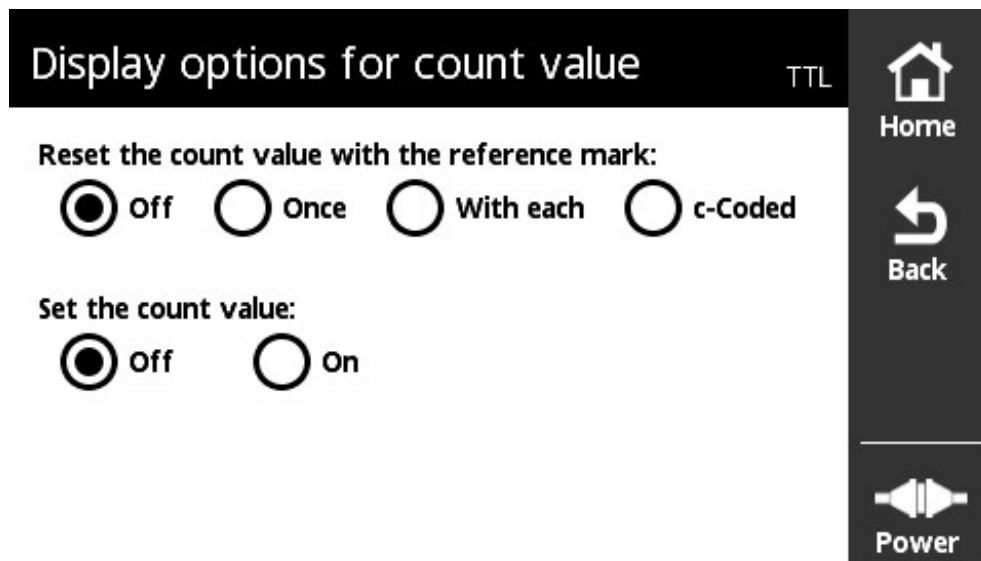

Figure 49: Display options for count value screen

The **Display options for count value** screen enables you to define display options for the count value.



The setting options vary depending on the encoder functions. The product adapts the displayed setting options correspondingly.

Resetting the count value

The count value counts the signal periods of the incremental signals of the connected encoder. The count value is always an incremental value.

The **Reset the count value with the reference mark:** parameter provides the following options:

Selection	Description
Off	The count value counts the signal periods without any other starting conditions. If this option is selected, you can set the Set the count value: parameter to On and enter a starting value in the Count value [steps] field. After tapping Back, the count value is set to the starting value entered and the product starts counting.
Once	The count value is set to "0" and counting starts with the detection of the reference mark. When the count value is detected, the parameter is set to Off again.
With each	The count value is set to "0" and counting starts with the detection of the reference mark. When the next reference mark is detected, the count value display freezes for approx. 0.5 s. This enables you to check the number of signal periods between reference marks for distance-coded encoders, for example.
c-Coded	The count value is set to "0" and is then changed to the corresponding count value after the coding of the reference marks has been detected. When the count value is detected, the parameter is set to Off again.

Defining the count values

The **Set the count value:** parameter contains the starting value from which the product starts counting. The following instruction describes the entry of the count value:

- ▶ Tap **More**
- ▶ The **More** menu is opened
- ▶ Tap **Counter**
- ▶ The **Display options for count value** screen is opened
- ▶ Tap the **Off** option of the **Reset the count value with the reference mark:** parameter
- ▶ Tap the **On** option of the **Set the count value:** parameter
- ▶ **Count value [steps]** is displayed
- ▶ Tap **Count value [steps]**
- ▶ The product's on-screen keyboard is opened
- ▶ Enter the desired starting value
- ▶ Tap **OK**
- ▶ Tap **Back**
- ▶ The changed settings take effect
- ▶ The **Display options for count value** screen is closed

Analysis information screen

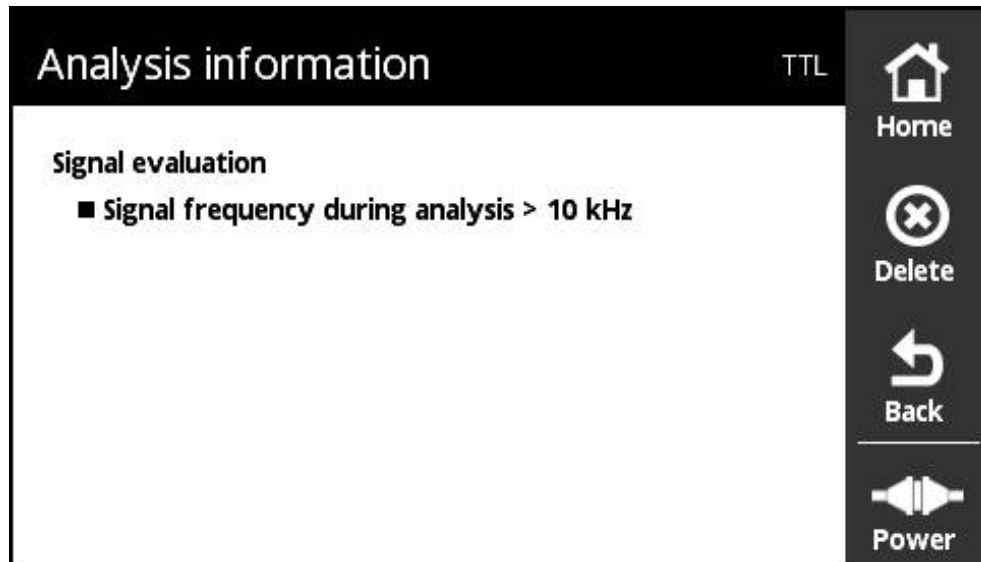

Figure 50: **Analysis information** screen

The **Analysis information** screen shows messages on the signal analysis.



The messages depend on the encoder functions. You can reset the messages.

Classification of signal messages

Signal messages from the **PWT display** screen are classified as follows:

Message	Category	Description
Frequency exceeded	Signal evaluation	Signal frequency too high, the testing tolerances can no longer be guaranteed
Reference mark not correctly detected	Signal evaluation	The reference mark was not correctly detected

Signal messages called from the **Level display** screen are classified as follows:

Message	Category	Description
Frequency exceeded	Signal evaluation	Signal frequency too high, the testing tolerances can no longer be guaranteed

Opening Analysis information



- ▶ Tap **More**
- > The **More** menu is opened



- ▶ Tap **Analysis**
- > The **Analysis information** screen is opened

Clearing status messages



- ▶ Correct the error(s) displayed in the status message
- ▶ Tap **Delete**
- > Status messages about errors that have been corrected will be deleted
- > Status messages about errors that continue to exist will continue to be displayed
- ▶ If required, repeat this procedure until all pending status messages have been deleted



- ▶ Tap **Back**
- > The screen that was last selected is opened

Display settings screen

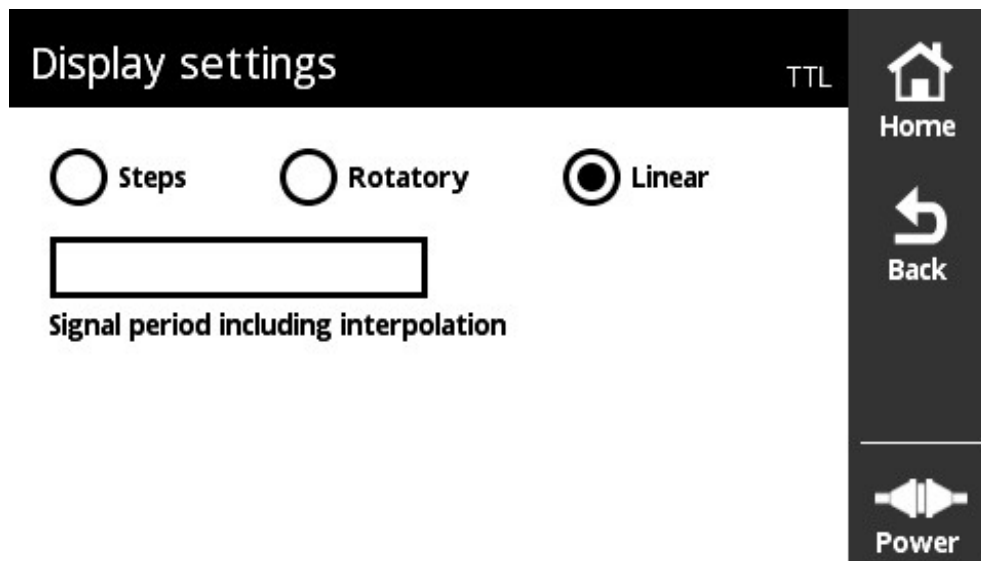

Figure 51: **Display settings** screen

The **Display settings** screen enables you to change the units of the measured values of the encoder. The setting has an effect on the count values displayed.

Selection	Description
Steps	Incremental display of counting values. Indicated in signal periods.
Rotatory	The count values are displayed as Angle [degrees] . Indicates the signal periods per revolution including interpolation. The following formula shows the calculation: $\text{Signal period per revolution} = \text{line count} \times \text{interpolation factor}$
Linear	The count values are displayed as Position [μm] . You have to enter the signal period including interpolation. The following formula shows the calculation: $\text{Signal period including interpolation} = \frac{\text{signal period}}{\text{interpolation factor}}$



The choice of the count-value unit affects all screens except for the **PWT display**.



More

- ▶ Tap **More**
- > The **More** menu is opened



Units

- ▶ Tap **Units**
- > The **Display settings** screen is opened

8.6.7 Encoder status screen for TTL/HTL/HTLs

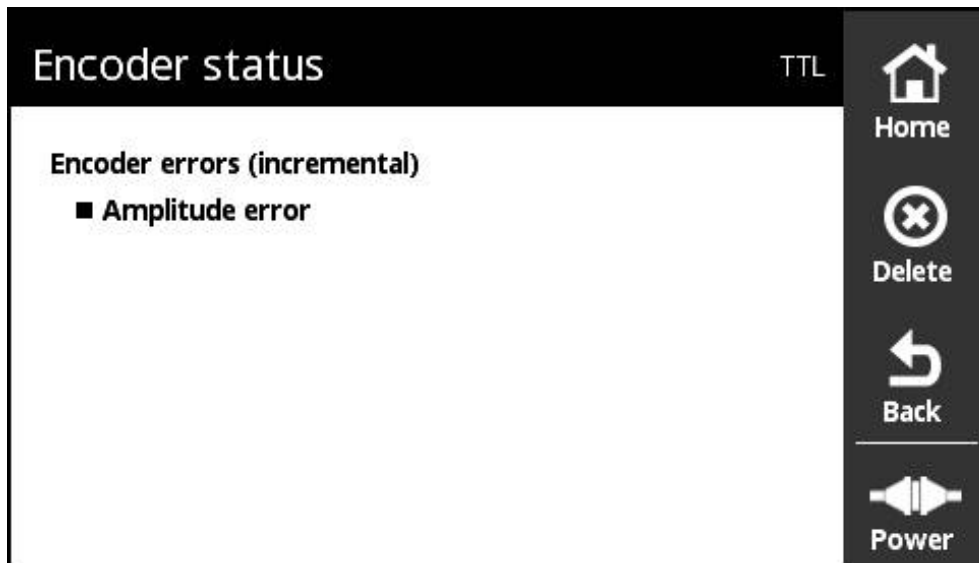

Figure 52: **Encoder status** screen (TTL)

The **Encoder status** screen displays encoder errors. The **Encoder status** screen can be opened from the following screens, using the **Status** button:

- **PWT display** screen
- **Counts** screen
- **Switching signals** screen
- **Level display** screen

Classification of status messages

The messages displayed by the product for the TTL interface are classified as follows:

Status screen	Message	Description
Red	Amplitude error	Signal amplitude is too small ($< 0.3 V_{PP}$ or $3 \mu A_{PP}$) or too large ($> 1.35 V_{PP}$ or $18 \mu A_{PP}$)
Red	Counting error	A counting error occurred (counting order Ua1, Ua2 is incorrect or the counting interval is too small)
Red	Fault-detection signal	For more information, please refer to the documentation about the encoder or the "Interfaces of HEIDENHAIN Encoders" brochure.
Red	Invalid numerical value between two reference marks	An incorrect count value was detected while checking the position during reference-mark crossover. Example: When using a rotational encoder with a reference mark, a distance of 0 or the line count must always be detected between two reference marks.
Red	Reference mark not found	A reference mark that was expected due to the current position value could not be identified. Example: When using a rotational encoder with a reference mark, a reference mark must always be identified at position 0 after referencing.

Clearing status messages



- ▶ Correct the error(s) displayed in the status message
- ▶ Tap **Delete**
- > Status messages about errors that have been corrected will be deleted
- > Status messages about errors that continue to exist will continue to be displayed
- ▶ If required, repeat this procedure until all pending status messages have been deleted



- ▶ Tap **Back**
- > The screen that was last selected is opened

8.7 Diagnosis for encoders with DRIVE-CLiQ interface

8.7.1 Online diagnostics screen

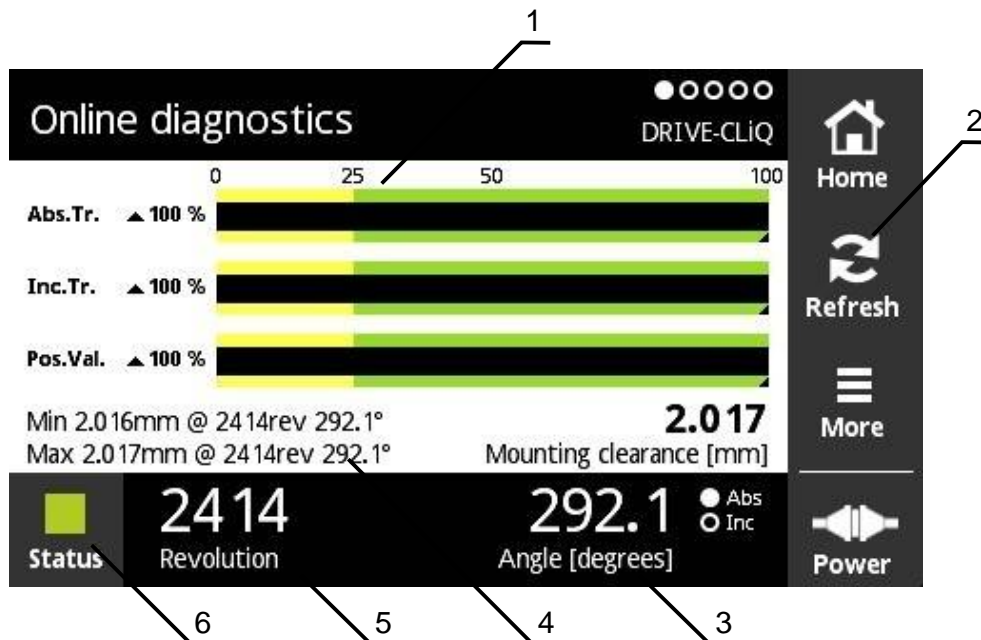

Figure 53: **Online diagnostics** screen

- 1 Status bars
- 2 Reset the minimum values
- 3 Position display
- 4 Mounting clearance
- 5 Revolutions
- 6 Status

The **Online diagnostics** screen uses status bars to display the current diagnostic values of an encoder with DRIVE-CLiQ interface. For the supported interfaces see "Information on the product", Page 10.

Status bars for function reserves

The status bars (1) of the **Online diagnostics** screen show the status of the function reserves. Up to four function reserves are supported, depending on the encoder.

The following function reserves are displayed for absolute encoders with serial interfaces:

- **Abs.Tr.:** Absolute track
- **Inc.Tr.:** Incremental or scanning track
- **Pos.Val.:** Position value calculation

The following function reserves are displayed for incremental encoders with purely serial interfaces:

- **Inc.Tr.:** Incremental or scanning track
- **Ri.Width:** Reference pulse width
- **Ri.Pos.:** Reference pulse position

Display



Figure 54: Display of the function reserves

The product displays the function reserves in a bar graph:

- 0 % to 25 %: Yellow range → Servicing/maintenance recommended
- 25 % to 100 %: Green range → The encoder is within the specification



There is a time difference of approx. 10 ms between the calculation of the position and the valuation numbers.

Resetting the minimum values

You can reset the minimum values displayed in the **Online diagnostics** screen.



- ▶ Tap the **Refresh** button
- > The displayed minimum values are reset

Diagnostic values of online diagnostics

Position display

The **Angle [degrees]** (3) position display shows absolute or incremental position values depending on the encoder model.

- **Abs**: Absolute position value
- **Inc**: Incremental position value
 - **Inc** shown in yellow: Reference mark not yet detected
 - **Inc** shown in white: Reference mark detected

Tapping the display opens the **Datum shift** screen.

Further information: "Datum shift screen ", Page 66

Revolutions

Revolutions (5) shows the number of revolutions performed depending on the encoder model.

Tapping the display opens the **Datum shift** screen.

Further information: "Datum shift screen ", Page 66

Status

The **Status** display (6) shows whether there are any messages about the connected encoder.

- Green: There are no messages
- Red: There are messages

Tapping the display opens the **Encoder status** screen.

Further information: "Encoder status screen", Page 70

Mounting clearance

The values shown in **Mounting clearance [mm]** (4) make it easy to verify if the encoder is mounted correctly.

Certain encoders generate values, such as the mounting clearance, that enable you to easily verify if the encoder is mounted correctly. If supported by the encoder, these values are transferred via the interface and displayed by the product in the **Online diagnostics** screen.



For the nominal values of the mounting clearance, refer to the mounting instructions for the respective encoder.

8.7.2 Temperature screen

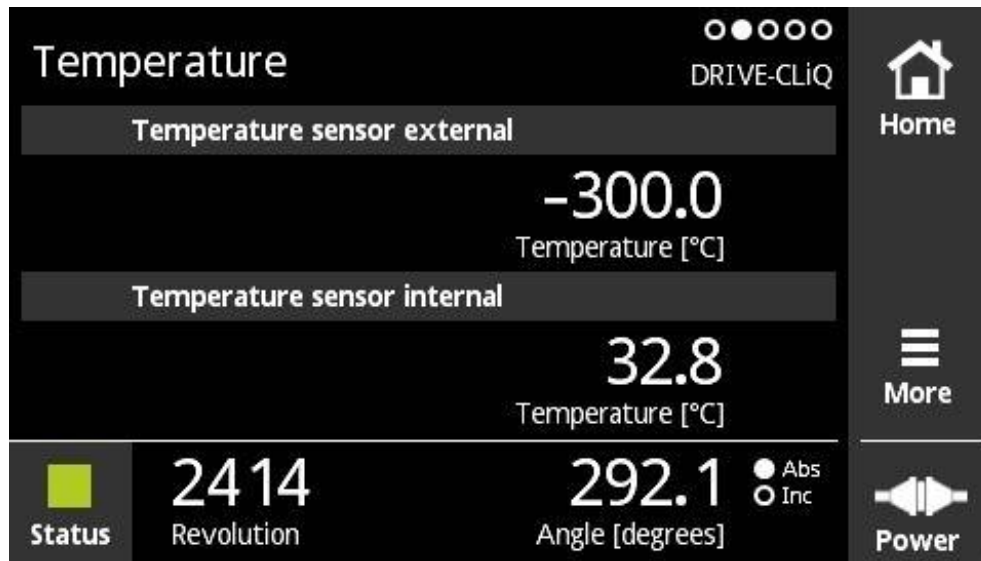

Figure 55: **Temperature** screen

The **Temperature** screen displays the temperature values measured by the internal temperature sensor and the external temperature sensor of the connected encoder.

Precondition: The encoder has an internal temperature sensor as well as an external temperature sensor and supports this function.

i If the connected encoder has only one temperature sensor or none at all, the product will display the **Sensor is not supported** message instead of a measured temperature value.

You can change the unit of the measured temperature values. You can select °C or °F.

Further information: "General settings screen", Page 125

8.7.3 Encoder information screen

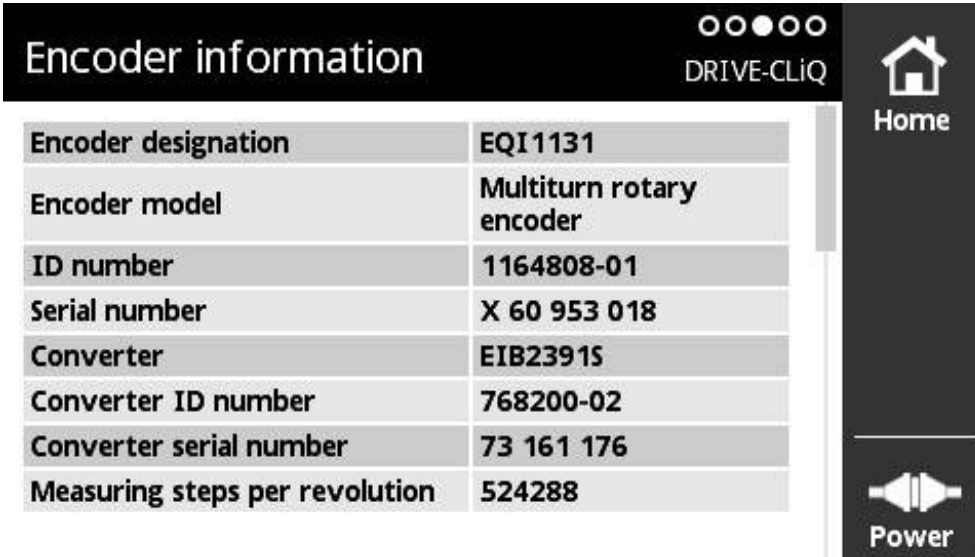

Encoder information	
Encoder designation	EQI1131
Encoder model	Multiturn rotary encoder
ID number	1164808-01
Serial number	X 60 953 018
Converter	EIB23915
Converter ID number	768200-02
Converter serial number	73 161 176
Measuring steps per revolution	524288

DRIVE-CLiQ

Home

Power

Figure 56: Encoder information screen

The **Encoder information** screen displays information saved about the connected encoder.

Precondition: The encoder supports this function.



The **Encoder information** screen displays only selected information on the connected encoder. This screen does not show the complete memory contents of the encoder.

8.7.4 Position screen

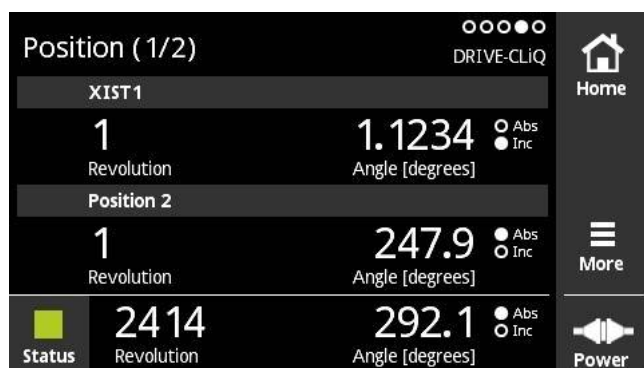

Figure 57: Position screen 1/2

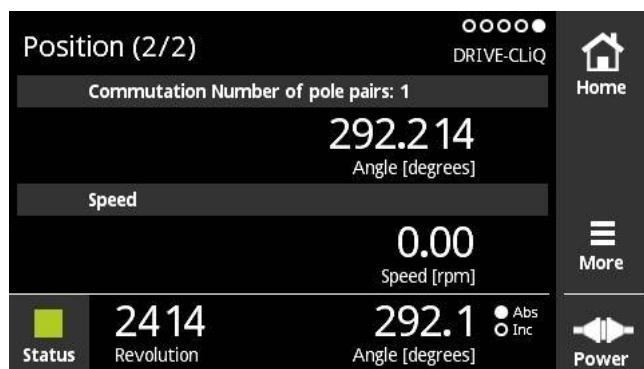

Figure 58: Position screen 2/2

The **Position** screen shows information on further position values as well as for commutation and speed.

Display	Description
Position display	Based on XIST2; absolute encoder position
XIST1	Incremental value of the encoder position
Position 2	For encoders that support functional safety: redundant position value
Commutation	Commutation angle with reference to the pole pair width (PPW): <ul style="list-style-type: none"> ■ The pole pair width (PPW) for linear encoders is 25 mm; i.e., 0° to 360° are displayed within 25 mm ■ The pole pair width for rotary or angle encoders is 1; i.e., 0° to 360° are displayed within one revolution
Speed	Current traversing speed or shaft speed Unit: Meters per second or revolutions per minute (depending on the encoder)

8.7.5 More menu

You can open the **More** menu from the following screens of the Diagnosis menus by using the **More** button:

- **Online diagnostics** screen
- **Temperature** screen
- **Position** screen

The **More** menu provides the following screens:

Screen	Function
Display settings	The Display settings screen enables you to change the units of the values measured by the connected encoder. The setting options vary depending on the encoder. Further information: "Display settings screen ", Page 65



- ▶ Tap **More**
- > The **More** menu is opened



Display settings screen

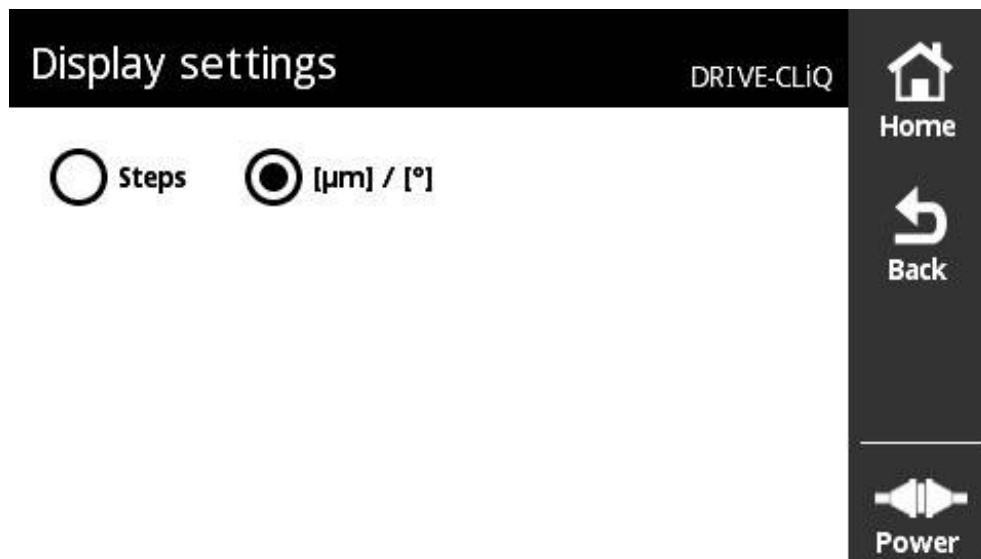

Figure 59: **Display settings** screen

The **Display settings** screen enables you to change the units of the values measured by the connected encoder. The setting options vary depending on the encoder.

Unit of measured position value

- Unit of encoder: μm or $^\circ$ (degrees)
- Steps [LSB] in the resolution of the connected encoder

Changing the unit of the measured position values

You can choose between displaying measured position values in μm , $^\circ$ (degrees), or steps.



If you select $\mu\text{m} / ^\circ$, the product will display the measured values in μm or in $^\circ$ (degrees), depending on the encoder.



More

- ▶ Tap **More**
- > The **More** menu is opened



Units

- ▶ Tap **Units**
- > The **Display settings** screen is opened
- ▶ Tap the desired unit
- > The desired unit takes effect



Back

- ▶ Tap **Back**
- > The changed settings take effect
- > The **Display settings** screen is closed

8.7.6 Encoder status screen

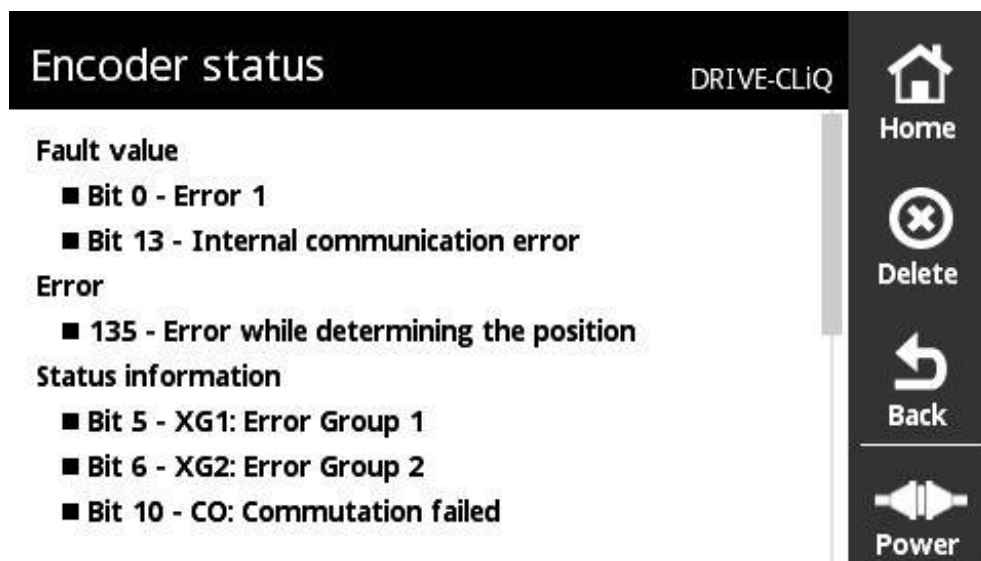

Figure 60: **Encoder status** (DRIVE-CLiQ) screen

The **Encoder status** screen can be called from the following screens, using the **Status** button:

- **Online diagnostics** screen
- **Temperature** screen
- **Position** screen

The **Encoder status** screen displays messages and warnings informing the user about errors that occurred on the encoder and about the transmission status of the encoder.

If you use the DRIVE-CLiQ interface to connect encoders to the product, the product evaluates the position data and status information each time position data is transmitted.

Classification of status messages

The messages displayed by the product for the DRIVE-CLiQ interface are classified as follows:

Message	Description
Transmission errors	Transmission errors indicate communication errors that may be caused by EMC influences, for example. The DRIVE-CLiQ interface provides measures for protecting the transmission between the encoder and the subsequent electronics from transmission errors. Transmission can be protected by means of a CRC (cyclic redundancy check), for example.
Encoder errors	Encoder errors indicate a malfunction of the encoder. If encoder errors are displayed, incorrect position values must be assumed.
Encoder warnings	Encoder warnings indicate that certain tolerance limits of the encoder have been reached or exceeded. The encoder warnings displayed do not state whether the measured position values are correct or incorrect.

The following message categories can occur:

Message	Description
Errors	Information about malfunctions of the encoder, e.g. <ul style="list-style-type: none"> ■ Encoder error ■ Software error ■ Kernel error ■ Safety error
Fault value	Detailed information on errors (if available for the respective error number)
Status information	Messages about the encoder status
Safety status	Messages about safety-relevant functions
Transmission status	Messages about communication errors, e.g. CRC error or packet loss

Clearing status messages



- ▶ Correct the error(s) displayed in the status message
- ▶ Tap **Delete**
- Status messages about errors that have been corrected will be deleted
- Status messages about errors that continue to exist will continue to be displayed
- ▶ If required, repeat this procedure until all pending status messages have been deleted



- ▶ Tap **Back**
- The screen that was last selected is opened

9

Settings menu

9.1 Overview

The **Settings** menu enables you to select the user interface language, change the unit of the measured temperature and make settings for screenshots. You can adjust the brightness of the display and restart the product.

The **Settings** menu provides the following screens:

Screen	Function
Language settings	The Language settings screen enables you to change the user interface language. Further information: "Language settings screen ", Page 124
General settings	The General settings screen enables you to change the unit of the measured temperature values and make settings for the designation of screenshots that you create on the product. Further information: "General settings screen", Page 125
Screen settings	The Screen settings screen enables you to adjust the brightness of the display and to rotate the display by 180°. Further information: "Screen settings screen ", Page 126
Restart device	The Restart device screen enables you to restart the product. Further information: "Restart device screen", Page 127

9.2 Language settings screen

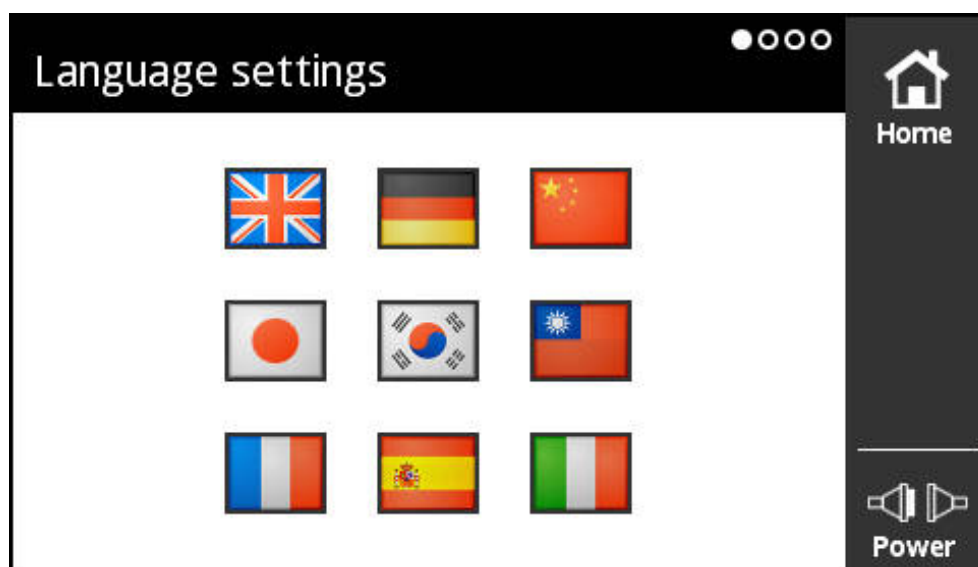

Figure 61: **Language settings** screen

The default language for the user interface is English.

The **Language settings** screen enables you to change the user interface language.

Setting the language



- ▶ Tap **Settings** in the **Main menu**
- > The **Language settings** screen is opened
- ▶ Tap the appropriate flag for the desired language
- > The **Language changed** message is displayed
- ▶ Tap **OK**
- > The user interface is displayed in the selected language

9.3 General settings screen

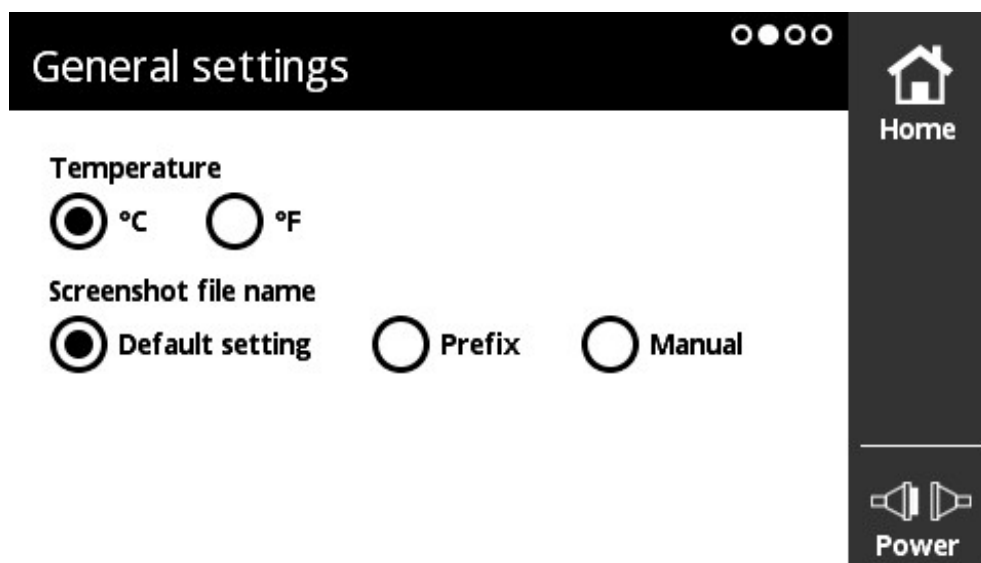

Figure 62: **General settings** screen

The **General settings** screen enables you to change the unit of the measured temperature values and make settings for the designation of screenshots that you create on the product.

Possible settings of the temperature unit

Selection	Function
°C	The measured values are displayed in degrees Celsius.
°F	The measured values are displayed in degrees Fahrenheit.

Setting the temperature unit



- ▶ Tap **Settings** in the **Main menu**
- > The **Language settings** screen is opened
- ▶ Swipe right to left
- > The **General settings** screen is opened
- ▶ Make your selection
- > The setting for the temperature unit is saved

Possible settings for the designation of screenshots

Selection	Function
Default setting	There are defined default file names for the individual screens. The screenshot is named in the following format: [language code]_[file name]_[number]
Prefix	The prefix can be entered via the on-screen keyboard. The screenshot is named in the following format:[prefix]_[number]
Manual	You can enter a different file name for each screenshot. When a screenshot has been created successfully, the input window opens automatically.



The date and time of a screenshot that was taken do not correspond to the current date and time. The product generates default values for the two values.

Setting the screenshot designation



- ▶ Tap **Settings** in the **Main menu**
- > The **Language settings** screen is opened
- ▶ Swipe right to left
- > The **General settings** screen is opened
- ▶ Make your selection
- ▶ If you select **Prefix**: Enter a file name prefix for screenshots
- > The settings for the screenshot designation are saved

9.4 Screen settings screen

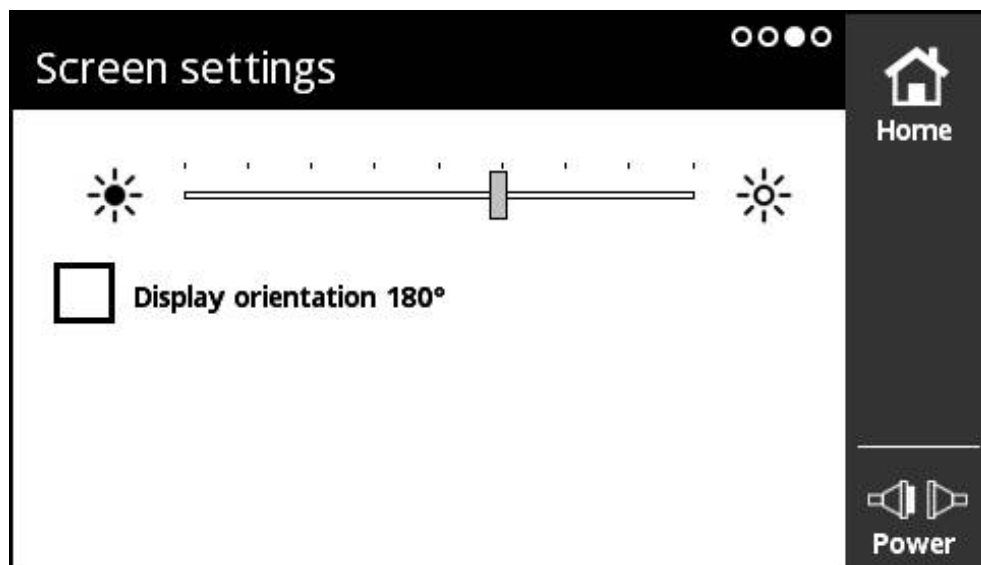

Figure 63: **Screen settings** screen

The **Screen settings** screen enables you to adjust the brightness of the display and to rotate the display by 180°.

Adjusting the brightness



- ▶ Tap **Settings** in the **Main menu**
- > The **Language settings** screen is opened
- ▶ Swipe right to left until the **Screen settings** screen is opened
- ▶ Drag the slider to the desired position
- > The brightness of the display is changed

Changing the display orientation



- ▶ Tap **Settings** in the **Main menu**
- > The **Language settings** screen is opened
- ▶ Swipe right to left until the **Screen settings** screen is opened
- ▶ Tap **Display orientation 180°**
- > The display is rotated by 180°

9.5 Restart device screen



Figure 64: **Restart device** screen

The **Restart device** screen enables you to restart the product.

Restarting the product



- ▶ Tap **Settings** in the **Main menu**
- > The **Language settings** screen is opened
- ▶ Swipe right to left until the **Restart device** screen is opened
- ▶ Tap the **Click here to restart the device.** button
- > The product is being restarted

10

**Module
management menu**

10.1 Overview

In the **Module management** menu, you manage the product's basic firmware and supplementary modules.

The **Module management** menu includes the following screens:

Screen	Function
Module management flash	In the Module management flash screen, you manage the modules that are saved in the product's flash memory. The non-volatile main memory of the product is called flash memory. Further information: "Module management flash screen", Page 131
Module management memory card	In the Module management memory card screen, you manage the modules that are saved on the memory card inserted in the product. Further information: "Module management memory card screen", Page 132
License key management	In the License key management screen, you manage the license keys for the supplementary modules. Further information: "License key management screen ", Page 135

10.2 Module management flash screen

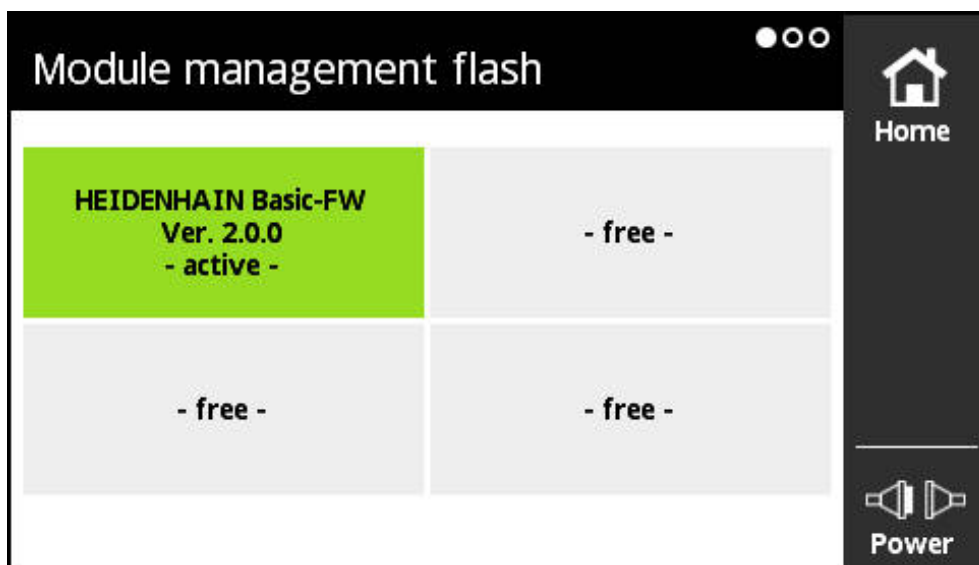



Figure 65: **Module management flash** screen

In the **Module management flash** screen, you manage the modules that are saved in the product's flash memory. The non-volatile main memory of the product is called flash memory.

No more than one module can be active in the product at a time. The currently active module is shown in green in the **Module management flash** screen. Other modules that are available but not activated are shown in black. Free module slots are shown in gray.

 The product is currently capable of managing up to four modules.

Tapping a module opens the **Module action** screen.

Further information: "Module action screen", Page 133

Opening the Module management flash screen



- ▶ Tap **Module management** in the **Main menu**
- The **Module management flash** screen of the **Module management** menu is opened

10.3 Module management memory card screen

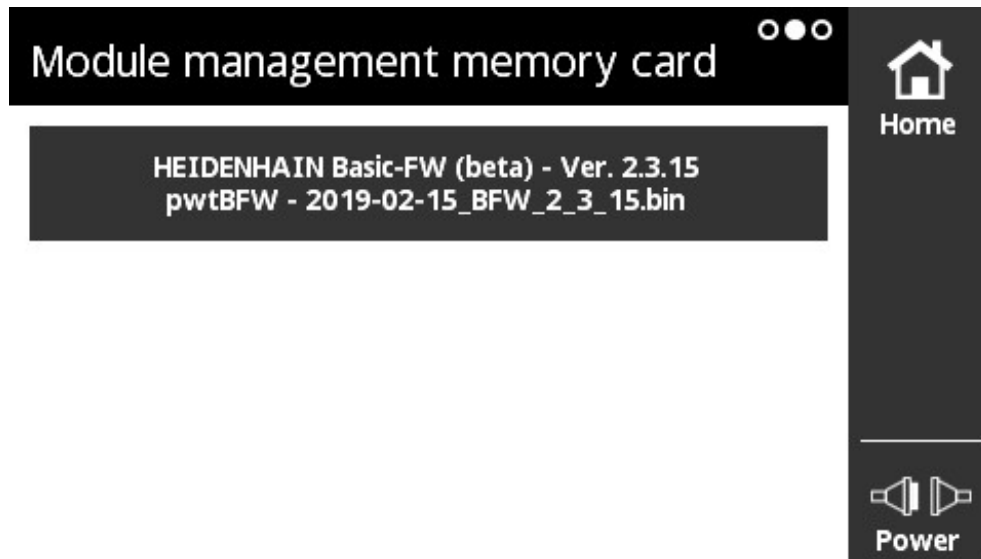

Figure 66: **Module management memory card** screen

In the **Module management memory card** screen, you manage the modules that are saved on the memory card inserted in the product.

The modules can be executed in the following ways:

- The module is executed locally from the memory card. Executing a module locally from the memory card is recommended for modules that are executed only once or infrequently.
- The module is transferred permanently to the flash memory of the product and takes up one of the available module slots. Permanent transfer to the flash memory is recommended for modules that are frequently used.

Tapping a module opens the **Module action** screen.

Further information: "Module action screen", Page 133

Opening the Module management memory card screen



- ▶ Tap **Module management** in the **Main menu**
- > The **Module management flash** screen of the **Module management** menu is opened
- ▶ Swipe right to left
- > The **Module management memory card** screen is opened

10.4 Module action screen

Tapping a module in the **Module management flash** or **Module management memory card** screen opens the **Module action** screen.

The available functions depend on the location where the module is saved (flash memory or memory card) and on the status of the module (active or inactive).

Module action in the flash memory screen

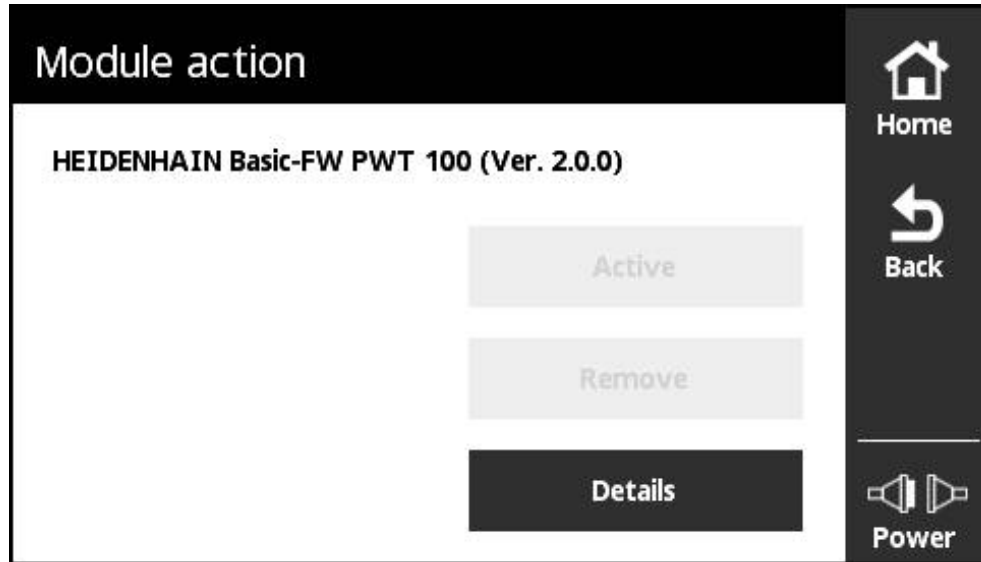

Figure 67: **Module action in the flash memory** screen

The following buttons are available for a module in the flash memory:

- **Active** (module is activated)
For information only, no action is possible
- **Start** (module is deactivated)
Start the module. This makes the module the active module.
- **Remove**
Remove the module from the flash memory (after confirmation prompt)
- **Details**
Information on the module

Module action on the memory card screen

Figure 68: **Module action on the memory card** screen

The following buttons are available for a module on the memory card:

- **Active** (module is activated)
For information only, no action is possible
- **Start** (module is deactivated)
Execute the module from the memory card. This makes the module the active module. The module is copied to the volatile main memory and executed there. The module is not transferred to the **Module management flash** memory. After a restart the module is executed again if it is still contained on the memory card. If not, the basic firmware is started by default.
- **Programming**
The module is transferred to the flash memory. This process may take some time (progress is shown). The module is transferred to the **Module management flash** memory.
- **Details**
Information on the module

10.5 License key management screen

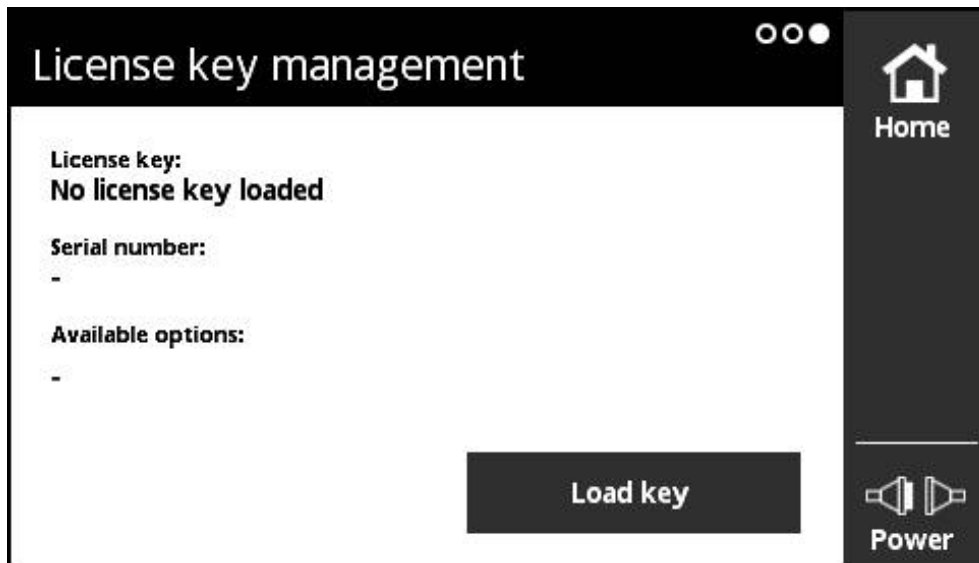

Figure 69: License key management screen

In the **License key management** screen, you manage the license keys for the supplementary modules.

The following information is displayed:

- **License key:** Current license key as character string
- **Serial number:** Unique serial number of the product for which the key was generated
- **Available options:** Numbers of the options included in the key

Function of the license key

Modules can provide various options that need to be enabled via a license key. These options are shown after you have tapped the **Details** button in the **Module information** screen.

Module information	
Flash slot	0
Type	BFW
Description	HEIDENHAIN Basic-FW (beta) PWT 100/101
Module version	2.3.15
Date	15.02.2019
Time	13:40:29
Required hardware version	1, 2, 3
Options	0

Home

Back



Power

Figure 70: **Module information** screen

A license key may include several options, but it always applies to the unique serial number of a product. License keys cannot be transferred. The license key is saved as a character string in the "prodkey.txt" ASCII file.

Prerequisite: The "prodkey.txt" file must be located in the main directory of the microSD memory card used.

Loading the license key



- ▶ Tap **Module management** in the **Main menu**
- > The **Module management flash** screen of the **Module management** menu is opened
- ▶ Swipe right to left until the **License key management** screen is opened
- ▶ Insert the microSD memory card with the license key into the slot (X4) of the product
- ▶ Tap the **Load key** button
- > The key is loaded

11

Information menu

11.1 Overview

The **Information** menu provides general information on the power supply of the product, the module version and hardware version, as well as license information.



This product uses open source software. For more information, refer to the included storage medium and to the **Information** menu on the product.

The **Settings** menu provides the following screens:

Screen	Function
Information	The Information screen provides general information on the power supply of the product, the module version and the hardware version. Further information: "Information screen", Page 138
Licenses	The Licenses screen provides license information. Further information: "Licenses screen ", Page 139

11.2 Information screen

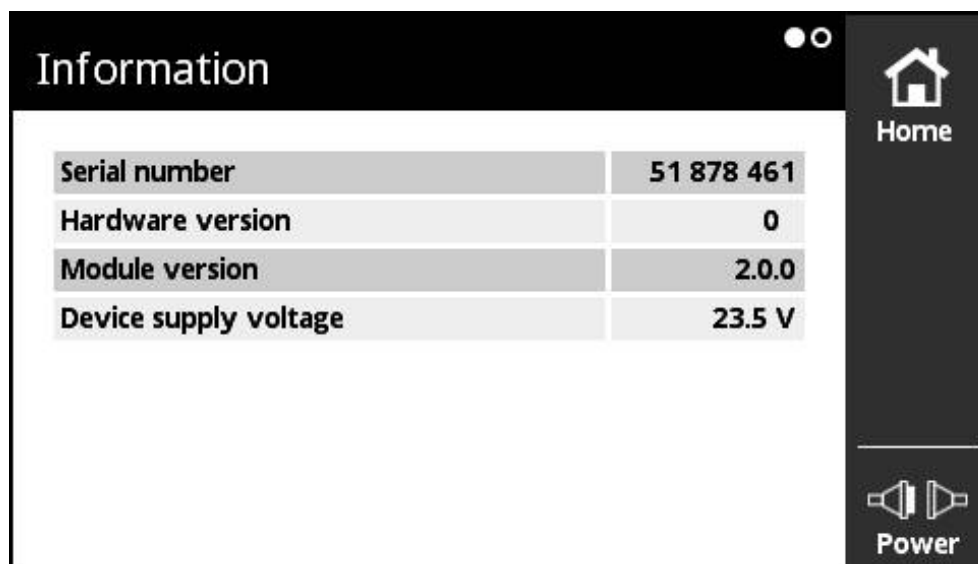

Figure 71: **Information** screen

The **Information** screen provides general information on the power supply of the product, the module version and the hardware version.

Calling information



- ▶ Tap **Information** in the **Main menu**
- > The **Information** screen is opened

11.3 Licenses screen

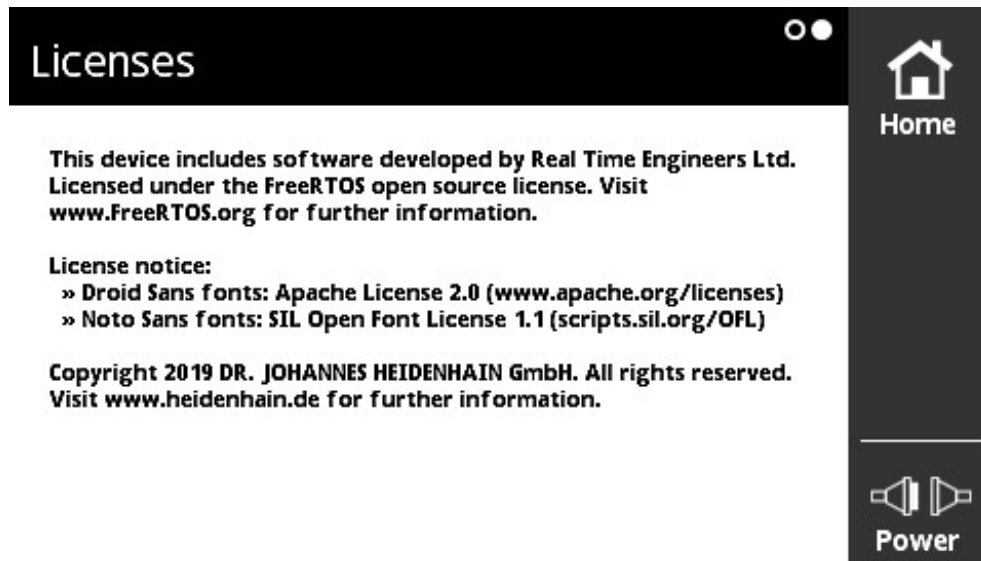

Figure 72: Licenses screen

The **Licenses** screen provides license information.

Calling license information



- ▶ Tap **Information** in the **Main menu**
- > The **Information** screen is opened
- ▶ Swipe right to left
- > The **Licenses** screen is opened

12

**Servicing and
maintenance**

12.1 Overview

This chapter describes the general maintenance work on the product.



This chapter contains a description of maintenance work for the product only.

Further information: Manufacturer's documentation for the respective peripheral devices

12.2 Cleaning

NOTICE

Cleaning with sharp-edged objects or aggressive cleaning agents

Improper cleaning will cause damage to the device.

- ▶ Never use abrasive or aggressive cleaners, and never use strong detergents or solvents
 - ▶ Do not use sharp-edged objects to remove persistent contamination
-
- ▶ Use only a cloth dampened with water and a mild detergent for cleaning the exterior surfaces
 - ▶ Use a lint-free cloth and a commercially available glass cleaner to clean the display

12.3 Maintenance schedule

The product is largely maintenance-free.

NOTICE

Operating defective devices

Operating defective devices may result in serious consequential damage.

- ▶ Do not repair or operate the device if it is damaged
- ▶ Replace defective devices immediately or contact a HEIDENHAIN service agency



The following steps are only to be performed by electrical specialists.

Further information: "Personnel qualification", Page 19

Maintenance step	Interval	Corrective action
▶ All labels and symbols provided on the product must be checked for readability	Annually	▶ Contact HEIDENHAIN service agency
▶ Electrical connections must be function tested and checked for damage	Annually	▶ Replace defective cables. Contact HEIDENHAIN service agency if required
▶ Check the wall adapter power supply for improper insulation or weak points	Annually	▶ Replace the wall adapter power supply according to the specification

12.4 Updating the firmware



The files for the basic firmware and for reloadable modules are contained in the software download area at www.heidenhain.com. Please also note the current information in the Addendum and the Release Notes.

Preparing the update

- ▶ Unpack the downloaded ZIP file to the computer
- ▶ Insert a suitable microSD memory card in the computer
- ▶ Delete any old firmware files with the extension *.bin that may be stored on the microSD memory card
- ▶ Save the unpacked new firmware file with the extension *.bin to the microSD memory card

Updating the basic firmware

- ▶ Switch off the product
- ▶ Insert the microSD memory card into the slot (X4) of the product
- ▶ Switch on the product
- ▶ Tap the **Module management** menu
- ▶ Swipe right to left to the **Module management memory card** screen
- ▶ Tap the firmware file
- ▶ Tap **Programming**
- ▶ Follow the instructions of the wizard
- > The firmware is activated and written to the flash memory.

Further information: "Module management memory card screen", Page 132

Managing the basic firmware

The basic firmware is managed in the **Module management** menu, because the basic firmware is also considered to be a module. As opposed to other modules, the following constraints apply to the basic firmware:

- The basic firmware must be stored in the flash memory of the product
- The basic firmware can be updated, but it cannot be deleted
- After the basic firmware has been updated, the product will automatically be restarted

13

What to do if ...

13.1 Overview

This chapter describes the causes of faults or malfunctions of the product and the appropriate corrective actions.

13.2 Malfunctions

If faults or malfunctions that are not listed in the "Troubleshooting" table below occur during operation, refer to the machine tool builder's documentation or contact a HEIDENHAIN service agency.

13.3 Troubleshooting



Faults or malfunctions that occur after the product has been switched on and while it is being used are displayed in the **Encoder status** screen of the product.

Further information: "Encoder status screen ", Page 90

Faults or malfunctions that may occur before or during switch-on of the product are listed in the following table.

DANGER

Serious personal injury or death by electric shock!

Any work on line voltage that is performed by personnel without the necessary qualification may result in serious personal injury or death.

The working steps listed in the following table must be performed only by personnel with the qualification specified in the table.

Fault	Cause of fault	Correction of fault	Personnel
The status LED on the wall adapter power supply remains dark after connecting the product to the power outlet.	No supply voltage	▶ Check the power connection	Service technician
	The product does not function properly	▶ Contact a HEIDENHAIN service agency	Service technician
The status LED on the wall adapter power supply shines after connecting the product to the power outlet, but the display of the product remains dark.	The connection between the wall adapter power supply and the product is interrupted	▶ Check the wall adapter power supply and the connecting cable of the product for correct connections	Service technician
	The product does not function properly	▶ Contact a HEIDENHAIN service agency	Service technician
Display remains empty	A software error occurred when the product was started	▶ Switch the product off and then on again ▶ Remove the MicroSD memory card before switch-on ▶ If the fault recurs, contact a HEIDENHAIN service agency	Service technician
After startup, the product does not recognize any entries made on the touchscreen.	Hardware initialization is faulty	▶ Switch the product off and then on again	Service technician

14

**Removal and
disposal**

14.1 Overview

This chapter provides information about the removal and disposal of the product. This information includes requirements to be complied with in respect of environmental-protection laws.

14.2 Removal from numerically controlled machines

WARNING

Serious personal injury or property damage caused by improper use of the NC!

Improper use caused by incorrect operation of the NC, incorrect NC programming, incorrect or non-optimized machine parameter values

- ▶ Observe the safety precautions applicable for the installation
- ▶ Acquire fundamental knowledge about machine, servo drives, inverters and NCs as well as their interaction with the encoders so that faulty behavior of a numerically controlled machine can be assessed correctly
- ▶ Apart from the information in these instructions, observe the specific safety regulations and accident prevention regulations when handling the respective machines, drives, inverters, and NCs
- ▶ When the product is removed from a machine or used in other special applications, all safety precautions detailed in these instructions must be adapted to the respective conditions of use
- ▶ Comply particularly with the required adaptations to changed grounding situations during installation and during connection of the product to the control loop of a numerically controlled machine
- ▶ The machine manufacturer must be contacted for fault diagnosis

Preparation

- ▶ Disconnect the wall adapter power supply from the product
- ▶ Disconnect all connections of the product

Repackaging

Repackaging should correspond to the original packaging as closely as possible:

- ▶ Connect all screw-mounting elements to the product or repackage them in the same way they were originally shipped from the factory
- ▶ Repackage the product in the shipping case or box as originally shipped from the factory
- ▶ Place all other components in the original packaging as received from the factory

Further information: "Items supplied and accessories", Page 24

- ▶ Enclose the entire documentation that was included in the original packaging.

Further information: "Storage and distribution of the documentation", Page 13



When returning the product for servicing, it is **not** necessary to ship the accessories and measuring devices with the product.

Storage after removal

If you want to store the product temporarily after removal, the specified ambient conditions must be complied with

Further information: "Specifications", Page 153.

14.3 Disposal**NOTICE****Incorrect disposal of the device!**

Incorrect disposal of the device can cause environmental damage.

- ▶ Do not dispose of electrical waste and electronic components in domestic waste
- ▶ Forward the device to recycling in accordance with the applicable local disposal regulations

- ▶ If you have any questions about the disposal of the device, please contact a HEIDENHAIN service agency

15

Specifications

15.1 Product data

Electrical data of the device

Power supply DC 24 V \pm 10 %, max. 15 W

Measurement of supply voltage and supply current

- Voltage: \pm 1 %
min. \pm 10 mV
- Current: \pm 2 %
min. \pm 1 mA

Electrical data of the wall adapter power supply

The wall adapter power supply must comply with the following specifications:

Rated voltage DC 24 V \pm 10 %

Leakage current < 0.25 mA

Electrical separation through the use of SELV or PELV circuit

Encoder input X1

15-pin D-sub connection, female

- Current limit: 750 mA @ 5 V (< 5 W/U_P)



Information about the cable lengths:

When using HEIDENHAIN cables:

Ensure that the supply voltage range of the encoder is maintained.

EnDat 2.1/2.2

- Cable length:
Functional limit < 100 m, depending on clock frequency
Compliance with test limits < 2 m (only incremental signals)
- Input frequency of incremental signals ¹⁾:
< 1000 kHz

1 V_{PP}

- Cable length:
Functional limit < 150 m
Compliance with test limits < 2 m
- Input frequency of incremental signals ²⁾:
< 1000 kHz

TTL

- Cable length:
Functional limit < 100 m/50 m, depending on min. edge separation
Compliance with test limits < 2 m
- Input frequency of incremental signals ²⁾:
< 1000 kHz
- Edge separation > 20 ns

11 μ A_{PP}

- Cable length:
Functional limit < 30 m
Compliance with test limits < 2 m
- Input frequency of incremental signals ²⁾: < 300 kHz

Encoder input X1

Fanuc	■ Cable length:
Mitsubishi	Functional limit < 30 m
Yaskawa	
Panasonic	

- 1) If supported by the connected encoder
- 2) Cutoff frequency may be reduced for certain measuring functions

External functions X2

6-pin mini-DIN-connection, female

Slot for memory card X4

Type of memory card	microSD memory card, FAT32 formatting, capacity ≥ 4 GB (recommended)
---------------------	---

Data interface X5

USB	High-speed USB 2.0
-----	--------------------

Encoder input X6

8+2-pin RJ45 connection, female

DRIVE-CLiQ ¹⁾	■ Cable length:
	Functional limit < 30 m

- 1) DRIVE-CLiQ is a registered trademark of Siemens AG

Test limits

Parameter	Input frequency ≤ 10 kHz		
	1 V _{PP}	11 μ A _{PP}	TTL
Signal amplitude A, B, R	$\pm 3 \%$	$\pm 3 \%$	–
Signal amplitude ¹⁾			
Low level	–	–	± 0.1 V
High level			$\pm 3 \%$
Asymmetry	± 0.004	± 0.004	–
Signal amplitude ratio	$\pm 1 \%$	$\pm 1 \%$	–
On-off ratio error TV1 or TV2	$\pm 1^\circ$	$\pm 1^\circ$	$\pm 1^\circ$
Phase angle error	$\pm 1^\circ$	$\pm 1^\circ$	$\pm 1^\circ$
Reference pulse width	$\pm 5^\circ$	$\pm 5^\circ$	$\pm 1^\circ$
Reference pulse position	$\pm 2^\circ$	$\pm 2^\circ$	$\pm 1^\circ$

¹⁾ Signal amplitude (U_{a1} , $\overline{U_{a1}}$, U_{a2} , $\overline{U_{a2}}$, U_{a0} , $\overline{U_{a0}}$, $\overline{U_{aS}}$)

Ambient conditions

Operating temperature	0 °C to 40 °C, no condensation
Storage temperature	0 °C to 70 °C, no condensation
Max. contamination level	2
Protection EN 60529	IP 20

15.2 Device dimensions and mating dimensions

All dimensions in the drawings are in millimeters.

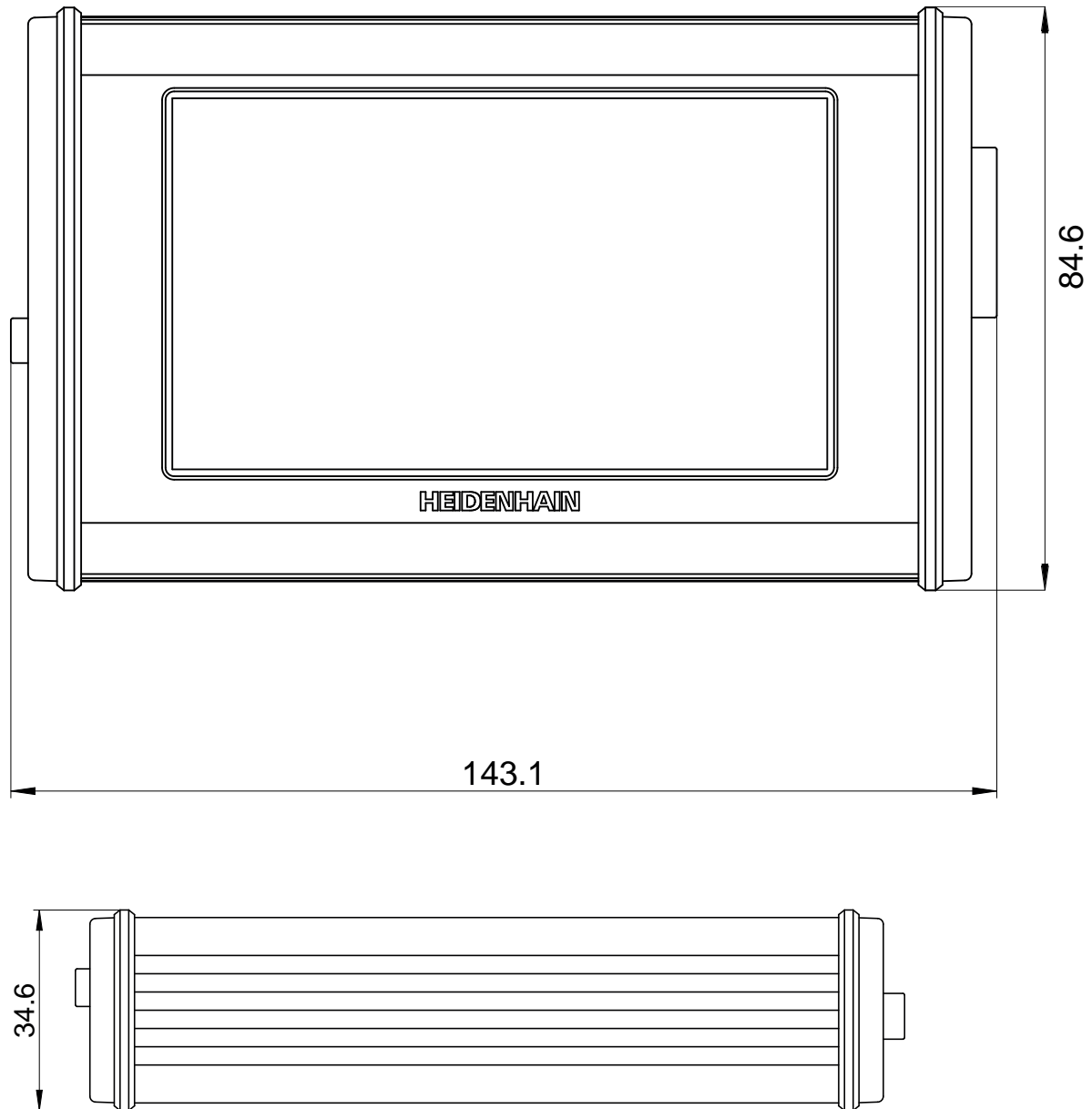

16 Index

A

Automatic diagnosis..... 55

C

Change screenshot designation.... 126
 Change temperature..... 125
 Changing position value
 units..... 65, 120
 Cleaning..... 142
 Connecting a computer..... 37
 Connecting the wall adapter power supply..... 45
 Connection
 Computer..... 37
 Encoders..... 36
 External device..... 38
 Wall adapter power supply.... 45
 Connection overview..... 31
 Count value..... 78, 101
 Creating a screenshot..... 43, 46

D

Damage in transit..... 24
 Datum shift
 Resetting..... 68
 Setting..... 68
 Diagnosis
 Automatic..... 55
 DRIVE-CLiQ interface..... 113
 HTL interface..... 92
 HTLs interface..... 92
 interface 1 Vpp (+Z1)/11 μApp 73
 Manual..... 56
 serial interface..... 58
 TTL interface..... 92

Display

Adjusting the brightness..... 127
 Cleaning..... 142
 Rotating the display..... 127
 Disposal..... 151

Documentation

Addendum..... 12
 download..... 11

E

Encoders
 Connecting..... 36
 Disconnecting the power supply..... 48
 HSP function..... 85, 105
 EnDat compliance..... 69

F

firmware..... 144
 Firmware version..... 10

function reserves..... 59, 113
 Function Settings
 Reference pulse..... 105
 Switching signals....
 85, 86, 106, 106
 Terminating resistor..... 84, 104

H

HSP function..... 85, 105

I

ID label..... 10
 Improper use..... 18
 Informational notes..... 14
 Installation Instructions..... 12
 Intended use..... 18
 Items supplied..... 24

L

License key management..... 135
 Loading the license key..... 136
 Locking function..... 83, 97

M

Main menu..... 40
 Maintenance schedule..... 143
 Malfunctions..... 146
 Manual diagnosis..... 56
 Menu
 Information..... 138
 More (1 Vpp, 11 μApp)..... 83
 More (DRIVE-CLiQ)..... 119
 More (serial)..... 64
 More (TTL/HTL/HTLs)..... 103
 Settings..... 124
 Module management..... 130
 Mounting..... 28
 Mounting clearance..... 60, 115
 Mounting location..... 28
 multiturn rotary encoders..... 68

O

Obligations of the operating
 company..... 19
 On-screen keyboard..... 44
 Operating elements..... 42
 Operating Instructions..... 12

P

Personnel qualification..... 19
 Position display..... 60, 63, 115, 118
 Position values
 Displaying..... 60, 63, 115, 118
 Power supply of the encoder.... 47
 Product
 Cleaning..... 142
 Connecting..... 32
 Mounting..... 28
 Restarting..... 127

Switch-off..... 45
 Switch-on..... 45
 Product data..... 154

R

Reference-mark detection.. 78, 101
 Reference mark position.... 77, 100
 Removal..... 150
 Repackaging..... 25
 Revolutions..... 60, 115

S

Safety precautions..... 13, 18
 Electrical..... 20
 General..... 19
 Peripheral devices..... 19

Screen

analysis information (1 Vpp,
 11 μApp)..... 88
 analysis information (TTL).... 108
 counts (1 Vpp, 11 μApp)..... 81
 datum shift (serial)..... 66
 display options for count value
 (1 Vpp, 11 μApp)..... 86
 display options for count value
 (TTL)..... 107
 display settings (1 Vpp,
 11 μApp)..... 89
 Display settings (DRIVE-
 CLiQ)..... 119
 Display settings (serial)..... 65
 display settings (TTL)..... 110
 encoder information (1 Vpp,
 11 μApp)..... 80
 Encoder information (DRIVE-
 CLiQ)..... 117
 encoder information (serial).... 62
 Encoder information (TTL/HTL/
 HTLs)..... 94
 encoder status (1 Vpp,
 11 μApp)..... 90
 Encoder status (serial)..... 120
 Encoder status (serial)..... 70
 Encoder status (TTL/HTL/
 HTLs)..... 111
 function settings (1 Vpp,
 11 μApp)..... 84
 function settings (TTL)..... 104
 general settings..... 125
 Information..... 138
 language settings..... 124
 level display (serial)..... 63
 Level display (TTL/HTL/
 HTLs)..... 93, 95
 license key management.... 135
 licenses..... 139
 Module action..... 133
 Module management flash.. 131

module management memory card.....	132
Online diagnostics (DRIVE-CLiQ).....	113
Online diagnostics (serial).....	58
Position (DRIVE-CLiQ).....	118
position (serial).....	63
PWT display (1 Vpp, 11 μ App)	73
PWT display (serial).....	63
PWT display (TTL).....	97
restart device.....	127
screen settings.....	126
sine commutation(1 Vpp + Z1).....	79
Switching signals (1 Vpp, 11 μ App).....	82
Switching signals (TTL).....	96
Temperature (DRIVE-CLiQ)...	116
temperature (serial).....	61
Service engineer.....	19
Setting the language.....	45, 125
Signal amplitude.....	75, 99
Signal deviations.....	76, 99
Storage.....	25, 151
Symbols and fonts used for marking text.....	15
Symbols on the product.....	20

T

Touchscreen gestures.....	43
---------------------------	----

W

Wall adapter power supply	
Electrical data.....	154
Replacing the adapter.....	32

Z

Zero crossover, reference mark signal.....	77, 101
--	---------

HEIDENHAIN

DR. JOHANNES HEIDENHAIN GmbH

Dr.-Johannes-Heidenhain-Straße 5

83301 Traunreut, Germany

☎ +49 8669 31-0

FAX +49 8669 32-5061

E-mail: info@heidenhain.de

Technical support FAX +49 8669 32-1000

Measuring systems ☎ +49 8669 31-3104

E-mail: service.ms-support@heidenhain.de

NC support ☎ +49 8669 31-3101

E-mail: service.nc-support@heidenhain.de

NC programming ☎ +49 8669 31-3103

E-mail: service.nc-pgm@heidenhain.de

PLC programming ☎ +49 8669 31-3102

E-mail: service.plc@heidenhain.de

APP programming ☎ +49 8669 31-3106

E-mail: service.app@heidenhain.de

www.heidenhain.de

