

AK ERM 2420: ID 1144042-xx
AK ERM 2480: ID 1144048-xx

Bei der Montage der Teilungstrommel Maße und Hinweise der Montageanleitung für die verwendete Teilungstrommel beachten.

When mounting the scale drum, comply with the dimensions and information provided in the Mounting Instructions for the scale drum.

Lors du montage du tambour gradué, respecter les cotes et les informations contenues dans les instructions de montage du tambour gradué utilisé.

Nel montaggio del tamburo, prestare attenzione alle dimensioni e alle indicazioni relative al tamburo utilizzato.

Durante el montaje del tambor graduado tener en cuenta las dimensiones y las indicaciones de las instrucciones de montaje para el tambor graduado utilizado.

HEIDENHAIN

Montageanleitung
Mounting Instructions
Instructions de montage
Istruzioni di montaggio
Instrucciones de montaje

AK ERM 2420 AK ERM 2480

Abtastkopf
Scanning Head
Tête caprice
Testina di scansione
Cabezal

Inhalt
Contents
Sommaire
Indice
Indice

Seite

- 4** Abmessungen
- 6** Allgemeine Hinweise
- 7** Montage
- 10** Anschlussbelegung

Page

- 4** *Dimensions*
- 6** *General Information*
- 7** *Mounting*
- 10** *Pin layout*

Page

- 4** Dimensions
- 6** Informations générales
- 7** Montage
- 10** Raccordements

Pagina

- 4** *Dimensioni*
- 6** *Informazioni generali*
- 7** *Montaggio*
- 10** *Piedinatura*

Página

- 4** Dimensiones
- 6** Información general
- 7** Montaje
- 10** Distribución del conector

Maße in mm
Dimensions in mm
Cotes en mm
Dimensioni in mm
Dimensiones en mm

Warnhinweise
Warnings
Recommendations
Avvertenze
Advertencias

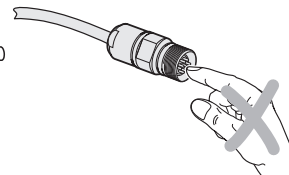
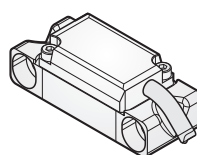

Achtung: Die Montage und Inbetriebnahme ist von einer qualifizierten Fachkraft unter Beachtung der örtlichen Sicherheitsvorschriften vorzunehmen.

- Die Steckverbindung darf nur spannungsfrei verbunden oder gelöst werden.
- Montageflächen müssen sauber und gratfrei sein.
- Der direkte Kontakt von Flüssigkeiten mit Messgerät und Steckverbinder ist zu vermeiden.
- Der Antrieb darf während der Montage nicht in Betrieb gesetzt werden.

Note: *Mounting and commissioning must be conducted by a qualified specialist in compliance with local safety regulations.*

- *Do not engage or disengage any connections while under power.*
- *Mounting surfaces must be clean and free of burrs.*
- *Avoid direct contact of fluids with the encoder and connector.*
- *The drive must not be put into operation during mounting.*

Attention: Le montage et la mise en service doivent être réalisés par un personnel qualifié, dans le respect des règles de sécurité locales.

- Ne procéder à des branchements/débranchements que lorsque l'appareil est hors tension.
- Les surfaces de montage doivent être propres et exemptes de bavures.
- Eviter tout contact direct de liquide sur le système de mesure et le connecteur.
- Ne pas actionner le système d'entraînement pendant le montage.

Attenzione: *far eseguire montaggio e messa in servizio da un tecnico specializzato in ottemperanza alle disposizioni di sicurezza locali.*

- *Collegare o staccare i collegamenti soltanto in assenza di tensione.*
- *Le superfici di montaggio devono essere pulite e senza bava.*
- *Evitare che lo strumento di misura e il connettore vengano a contatto con liquidi.*
- *L'azionamento non deve essere messo in funzione durante il montaggio.*

Atención: El montaje y la puesta en marcha deben ser realizados por un especialista cualificado, observando las prescripciones locales de seguridad.

- Conectar o desconectar el conector sólo en ausencia de tensión.
- Las superficies de montaje deben estar limpias y sin rebaba.
- ¡Evitar el contacto directo de líquidos con el sistema de medida y el conector.
- El accionamiento no debe ponerse en marcha durante el montaje.

Abmessungen
Dimensions
Dimensioni
Dimensiones



Tolerancing ISO 8015
 ISO 2768 - m H
 < 6 mm: ±0.2 mm

Ⓐ = Lagerung
 Bearing
 Roulement
 Cuscinetto
 Rodamiento

① = Kabelabstützung
 Cable support
 Support de câble
 Ingombro cavo
 Apuntalamiento del cable

② = Alternativer Kabelausgang
 Alternative cable outlet
 Sortie de câble alternative
 Uscita cavo alternativa
 Salida del cable alternativa

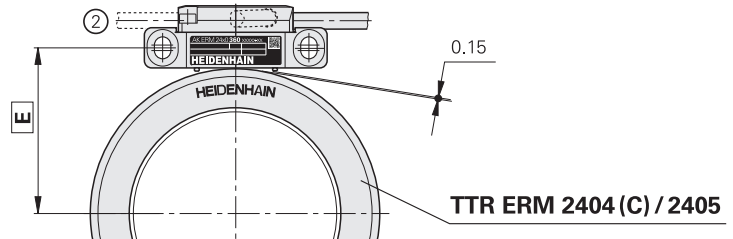
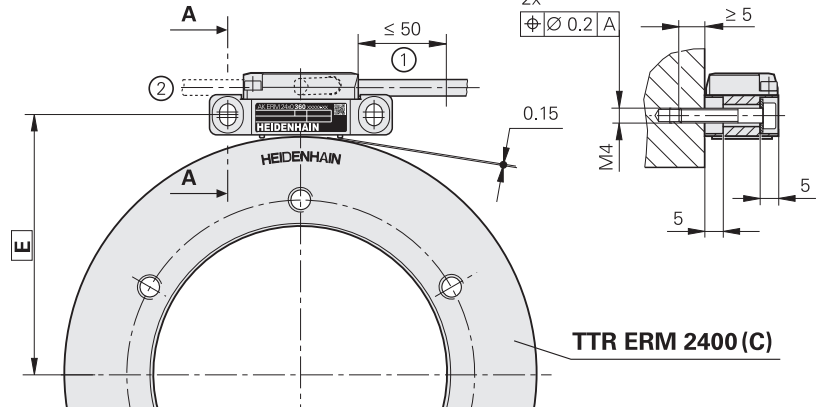
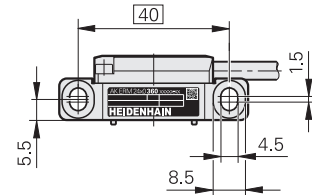
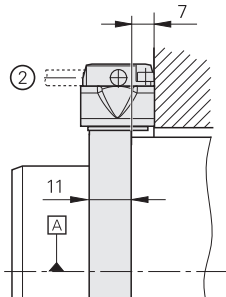
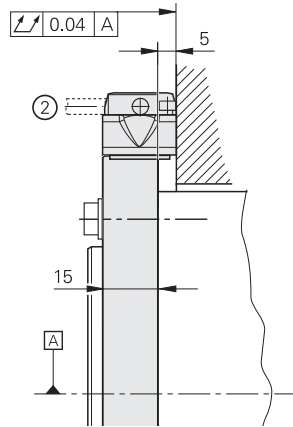

Z = Strichzahl
 Line count
 Nombre de traits
 Numero di impulsi
 Número de impulsos

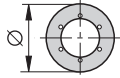

Z		E
360	∅ 45.26	28.3
400	∅ 50.29	30.9
512	∅ 64.37	37.9
600	∅ 75.44	43.4
720	∅ 90.53	51.0
900	∅ 113.16	62.3
1024	∅ 128.75	70.1
1200	∅ 150.88	81.2
1230	∅ 154.65	83.0
1400	∅ 176.03	93.7
1696	∅ 213.24	112.3
2048	∅ 257.50	134.5
2176	∅ 273.59	142.5
2600	∅ 326.90	169.2
2720	∅ 341.99	176.7
2880	∅ 362.11	186.8
3296	∅ 414.41	212.9
3600	∅ 452.64	232.0
3840	∅ 482.81	247.1
3850	∅ 484.07	247.7
4448	∅ 559.26	285.3
4800	∅ 603.52	307.5
5600	∅ 704.10	357.8

Bei Verwendung einer **TTR ERM 202/202C oder 209** sind Besonderheiten zu berücksichtigen.

Bitte beachten Sie hierzu die separate Anleitung.

*When using a **TTR ERM 202/202C or 209**, special characteristics must be taken into account.*

Please refer to the separate instructions.

Si vous utilisez un **TTR ERM 202/202C ou 209**, vous devrez tenir compte de certaines particularités.

Consulter pour cela les instructions dédiées.

*Utilizzando un **TTR ERM 202/202C o 209** sono da considerare alcune particolarità. Prestare attenzione alle istruzioni specifiche.*

Durante la utilización de un **TTR ERM 202/202C o 209** deben tomarse en consideración sus particularidades.

Para ello consultar las instrucciones específicas.

Allgemeine Hinweise
General Information
Informations générales
Informazioni generali
Información general

Maximale Fremd-Wechselfelder im Betrieb 2.5 mT.
 Maximale Fremd-Gleichfelder im Betrieb 5.0 mT.

Maximum external alternating fields during operation 2.5 mT.
Maximum external constant fields during operation 5.0 mT.

Champs alternants parasites max. en fonctionnement 2.5 mT.
 Champs continus parasites max. en fonctionnement 5.0 mT.

Massimo campo magnetico esterno alternato in lavoro 2.5 mT.
Massimo campo magnetico esterno unidirezionale in lavoro 5.0 mT.

Campos magnéticos alternos máximos en funcionamiento 2.5 mT.
 Campos magnéticos continuos máximos en funcionamiento 5.0 mT.

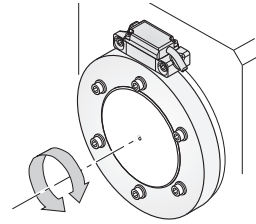

Mindestabstand von Störquellen
Minimum distance from sources of interference
 Distance minimale avec les sources de perturbation
Distanza minima dalla fonte di disturbo
 Distancia mínima respecto a las fuentes de interferencias

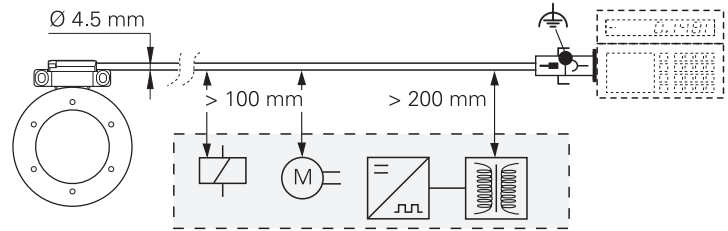

Zulässige Biegeradien des Anschlusskabels
Permissible bending radii of connecting cable
 Rayons de courbure admissibles pour le câble de raccordement
Raggio di curvatura consentito per il cavo di collegamento
 Radios de torsión admisibles del cable de conexión

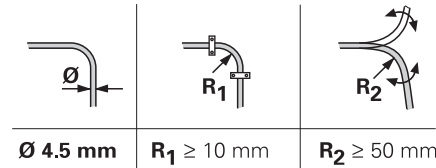

Montage
Assembly
Montage
Montaggio
Montaje

Achtung: Verletzungsgefahr durch drehende Teile.

- Drehende Teile sind nach erfolgtem Anbau gegen unbeabsichtigtes Berühren im Betrieb ausreichend zu schützen.

Warning: Risk of injury from rotating parts.

- After encoder installation, all rotating parts must be protected against accidental contact during operation.

Attention: danger de blessures par des pièces en rotation.

- En fonctionnement, des protections aux contacts involontaires doivent être mises en place sur les pièces en rotation après un montage réussi.

Attenzione: rischio di lesioni a causa di elementi rotanti.

- Prevedere protezioni da contatto accidentale con elementi in rotazione dopo il montaggio.

Atención: riesgo de accidente por causa de piezas en rotación.

- Una vez realizado el montaje requerido deben protegerse suficientemente las piezas en rotación ante contactos no previstos.

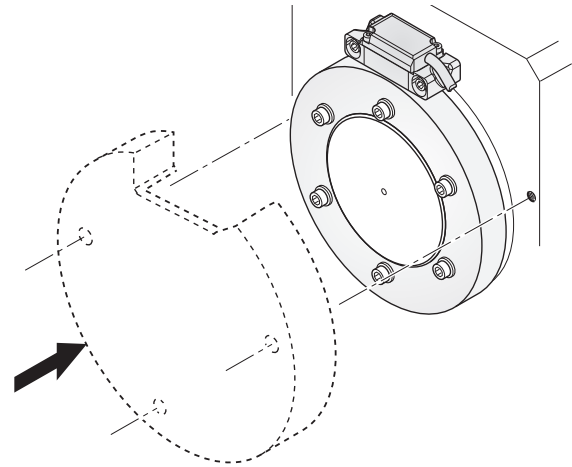

Montage
Assembly
Montage
Montaggio
Montaje

Abstandsfolie im Lieferumfang enthalten
Spacer foil included in delivery
Feuille d'écartement incluse dans la livraison
Pellicola distanziale nello standard di fornitura
Lámina espaciadora contenida en los elementos suministrados

Abtastkopf mit geringer Kraft gegen die Abstandsfolie und Anschraubfläche drücken und abwechselnd schrittweise festschrauben.
Abstandsfolie entfernen.

Gently press the scanning head against the spacer foil and the mounting surface, and secure it by tightening the provided screws alternately and gradually. Remove the spacer foil.

Appliquer une légère pression sur la tête caprice pour la positionner contre la feuille d'écartement et la surface de fixation, puis serrer progressivement les vis par alternance.

Retirer la feuille d'écartement.

Appoggiare la testina contro la pellicola distanziale e la superficie di fissaggio e serrare le viti alternativamente e gradualmente.

Rimuovere la pellicola.

Presionar con una fuerza leve el cabezal lector contra la lámina espaciadora y la superficie de atornillado y fijar los tornillos alternativamente uno a uno.

Retirar la lámina espaciadora.

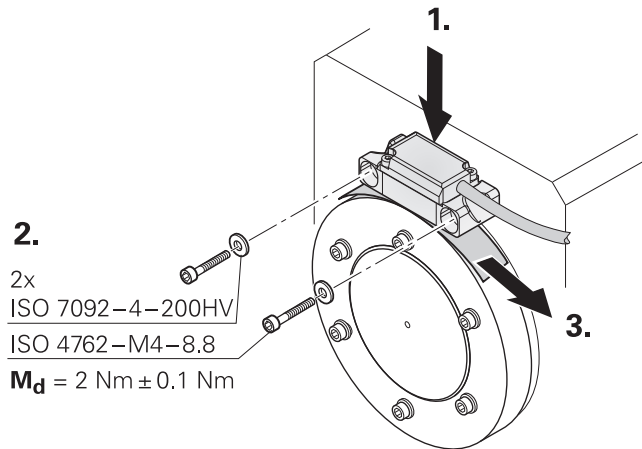
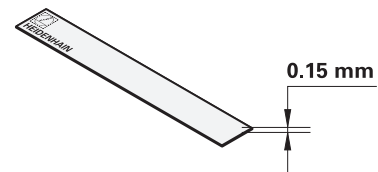

Elektrischen Widerstand zwischen Steckergehäuse und Maschine prüfen.

Sollwert: 1 Ω max.

Check the resistance between the connector housing and the machine.

Desired value: 1 Ω max.

Tester la résistance électrique entre le carter de la prise et la machine.

Valeur nominale: 1 Ω max.

Controllare la resistenza elettrica tra l'alloggiamento del connettore e la macchina.

Valore nominale: 1 Ω max.

Comprobar la resistencia eléctrica entre la carcasa del conector y la máquina.

Valor nominal: 1 Ω máx.

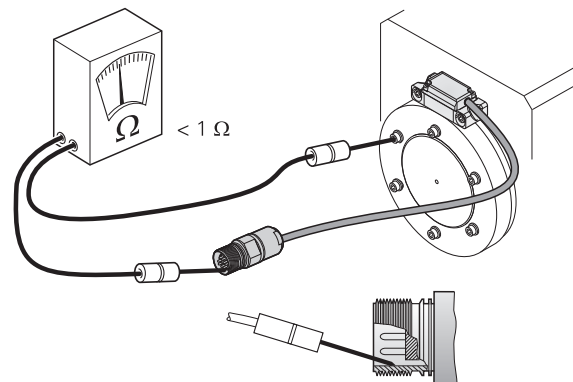

Anschlussbelegung

Pin Layout

Raccordements

Piedinatura

Distribución del conector

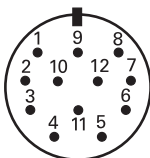
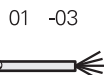

03S12-03

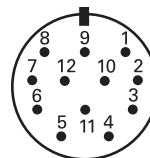
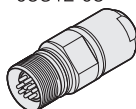

02S12-03

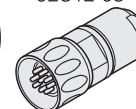

AK ERM 2420 TTL

	12	2	10	11	5	6	8	1	3	4	7
	U_P	Sensor U _P	0 V	Sensor 0 V	U_{a1}	$\overline{U_{a1}}$	U_{a2}	$\overline{U_{a2}}$	U_{a0}	$\overline{U_{a0}}$	$\overline{U_{aS}}$
	BNGN	BU	WHGN	WH	BN	GN	GY	PK	RD	BK	VT

Die Sensorleitung ist intern im Messgerät mit der Versorgungsleitung verbunden.

The sensor line is connected inside the encoder to the supply line.

La ligne de palpeur est reliée de manière interne dans le système de mesure à la ligne d'alimentation.

La linea del sensore è collegata internamente allo strumento di misura con la linea di alimentazione.

La línea de sensor está unida internamente en el aparato de medida con la línea de alimentación.

Außenschirm auf Gehäuse

External shield on housing

Blindage externe sur boîtier

Schermo esterno sulla carcassa

Blindaje externo a carcasa

Nicht verwendete Pins oder Adern dürfen nicht belegt werden!

Vacant pins or wires must not be used!

Les plots ou fils non utilisés ne doivent pas être raccordés!

I pin o i fili inutilizzati non devono essere occupati!

¡No conectar los pins o hilos no utilizados!



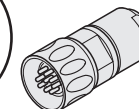
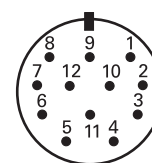
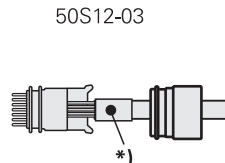
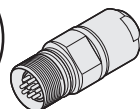
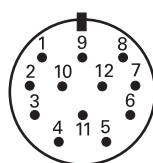
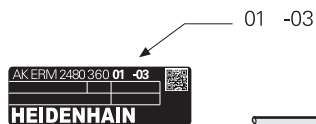

AK ERM 2480 1 VSS

	12	2	10	11	5	6	8	1	3	4
	Up	Sensor Up	0 V	Sensor 0 V	A+	A-	B+	B-	R+	R-
	BNGN	BU	WHGN	WH	BN	GN	GY	PK	RD	BK

Die Sensorleitung ist intern im Messgerät mit der Versorgungsleitung verbunden.

The sensor line is connected inside the encoder to the supply line.

La ligne de palpeur est reliée de manière interne dans le système de mesure à la ligne d'alimentation.

La linea del sensore è collegata internamente allo strumento di misura con la linea di alimentazione.

La línea de sensor está unida internamente en el aparato de medida con la línea de alimentación.

Außenschirm auf Gehäuse

External shield on housing

Blindage externe sur boîtier

Schermo esterno sulla carcassa

Blindaje externo a carcasa

*) Außenschirm auf Crimphülse

External shield on crimp sleeve

Blindage externe sur douille crimp

Schermo esterno sulla bussola a crimpare

Blindaje externo a casquillo de crimpado

Nicht verwendete Pins oder Adern dürfen nicht belegt werden!

Vacant pins or wires must not be used!

Les plots ou fils non utilisés ne doivent pas être raccordés!

I pin o i fili inutilizzati non devono essere occupati!

¡No conectar los pins o hilos no utilizados!



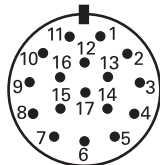

2ZS17-3M
2ZS17-ER *)

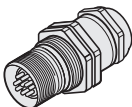

68S17-3M

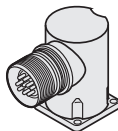

21S17-57

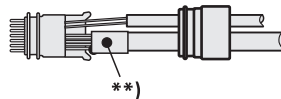

AK ERM 2480 1 V_{SS}

10	16	7	15	1	2	11	12	3	13
U_p	Sensor U_p	0V	Sensor 0V	A+	A-	B+	B-	R+	R-
BNGN	BU	WHGN	WH	BN	GN	GY	PK	RD	BK

8	9	5 *)	6 *)
T+	T-	T2+	T2-
BN	WS	GN	YE

Die Sensorleitung ist intern im Messgerät mit der Versorgungsleitung verbunden.

The sensor line is connected inside the encoder to the supply line.

La ligne de palpeur est reliée de manière interne dans le système de mesure à la ligne d'alimentation.

La linea del sensore è collegata internamente allo strumento di misura con la linea di alimentazione.

La línea de sensor está unida internamente en el aparato de medida con la línea de alimentación.

Außenschirm auf Gehäuse

External shield on housing

Blindage externe sur boîtier

Schermo esterno sulla carcassa

Blindaje externo a carcasa

****)** Außenschirm auf Crimphülse

External shield on crimp sleeve

Blindage externe sur douille crimp

Schermo esterno sulla bussola a crimpare

Blindaje externo a casquillo de crimpado

Nicht verwendete Pins oder Adern dürfen nicht belegt werden!

Vacant pins or wires must not be used!

Les plots ou fils non utilisés ne doivent pas être raccordés!

I pin o i fili inutilizzati non devono essere occupati!

¡No conectar los pins o hilos no utilizados!

T = Temperatursensor

Temperature sensor

Sonde de température

Sensore di temperatura

Sensor de temperatura



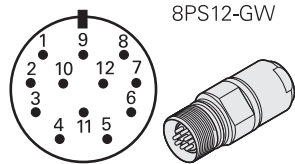
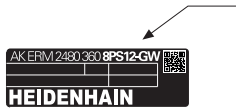

AK ERM 2480 1 VSS

12	2	10	11	5	6	8	1	3	4
Up	Sensor Up	0V	Sensor 0V	A+	A-	B+	B-	R+	R-
BNGN	BU	WHGN	WH	BN	GN	GY	PK	RD	BK

7	9
T+	T-
BN	WS

Die Sensorleitung ist intern im Messgerät mit der Versorgungsleitung verbunden.

The sensor line is connected inside the encoder to the supply line.

La ligne de palpeur est reliée de manière interne dans le système de mesure à la ligne d'alimentation.

La linea del sensore è collegata internamente allo strumento di misura con la linea di alimentazione.

La línea de sensor está unida internamente en el aparato de medida con la línea de alimentación.

Außenschirm auf Gehäuse

External shield on housing

Blindage externe sur boîtier

Schermo esterno sulla carcassa

Blindaje externo a carcasa

T = Temperatursensor
Temperature sensor
 Sonde de température
Sensore di temperatura
 Sensor de temperatura



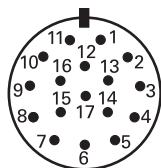

03S17-RI

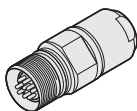

03S17-OT

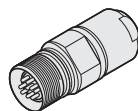

AK ERM 2480 1 V_{SS}

	10	16	7	15	1	2	11	12	3	13
	Up	Sensor Up	0V	Sensor 0V	A+	A-	B+	B-	R+	R-
	●	●	●	●						
03S17-RI	BNGN	BU	WHGN	WH	BN	GN	GY	PK	RD	BK
03S17-OT	BNGN	BU	WHGN	WH	GNBK	YEBK	BUBK	RDBK	RD	BK

Die Sensorleitung ist intern im Messgerät mit der Versorgungsleitung verbunden.

The sensor line is connected inside the encoder to the supply line.

La ligne de palpeur est reliée de manière interne dans le système de mesure à la ligne d'alimentation.

La linea del sensore è collegata internamente allo strumento di misura con la linea di alimentazione.

La línea de sensor está unida internamente en el aparato de medida con la línea de alimentación.

Außenschirm auf Gehäuse

External shield on housing

Blindage externe sur boîtier

Schermo esterno sulla carcassa

Blindaje externo a carcasa

Nicht verwendete Pins oder Adern dürfen nicht belegt werden!

Vacant pins or wires must not be used!

Les plots ou fils non utilisés ne doivent pas être raccordés!

I pin o i fili inutilizzati non devono essere occupati!

¡No conectar los pins o hilos no utilizados!





4KS08-A1

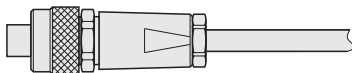
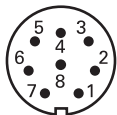

ERM 2480 1 Vss

	8	5	3	4	7	6	1	2
	Up	0V	A+	A-	B+	B-	R+	R-
	BNGN	WHGN	BN	GN	GY	PK	RD	BK

Außenschirm auf Gehäuse
External shield on housing
 Blindage externe sur boîtier
Schermo esterno sulla carcassa
 Blindaje externo a carcasa



HEIDENHAIN

DR. JOHANNES HEIDENHAIN GmbH

Dr.-Johannes-Heidenhain-Straße 5

83301 Traunreut, Germany

☎ +49 8669 31-0

FAX +49 8669 32-5061

E-mail: info@heidenhain.de

Technical support FAX +49 8669 32-1000

Measuring systems ☎ +49 8669 31-3104

E-mail: service.ms-support@heidenhain.de

TNC support ☎ +49 8669 31-3101

E-mail: service.nc-support@heidenhain.de

NC programming ☎ +49 8669 31-3103

E-mail: service.nc-pgm@heidenhain.de

PLC programming ☎ +49 8669 31-3102

E-mail: service.plc@heidenhain.de

Lathe controls ☎ +49 8669 31-3105

E-mail: service.lathe-support@heidenhain.de

www.heidenhain.de

1156255-01



1156255-00-B-01 · Printed in Germany · 6/2016 · H